

ADS-P Multi-tone alarm sounder with LED light indicator

- 94 mm cubic-design multi-tone alarm sounder with built-in LED steady/flashing light indicator
- Types of light can be switched externally
- For industrial and general applications
- UV-stabilised material
- Piezo technology, 8 tones, max. 103 dB (A) sound pressure
- Sound pressure infinitely adjustable by potentiometer
- High degree of protection IP 66 & impact resistance IK9
- Optional mounting type using metal bracke

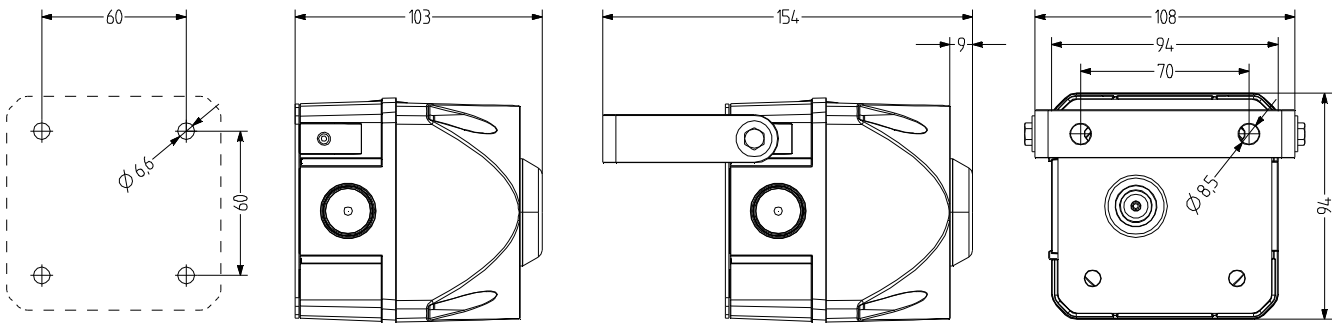

TECHNICAL DATA

Housing	94 mm (square), Polycarbonate red
Lens	Polycarbonate, ribbed inside orange, red, clear, blue, green or yellow
Type of mounting	any, Sound outlet opening at bottom or horizontal
Connection technology	Screw/plug-in terminal up to 2,5 mm ²
Beacon type	Steady beacon
Luminous intensity	1 Cd
Tone	8 Tones, 1 Tones can be switched externally, various (see tone table)

Volume	103 dB (can be adjusted with potentiometer)
Tone frequency	500-4.600 Hz
Duty cycle	100 %
Service life	Light source: 100.000 h
Operating temperature	-30 °C / +60 °C
Degree of protection	IP66
Impact resistance	IK09
Weight	310 g



ADS-P

ORDER DATA

Lens colour	Nominal voltage	Voltage range (V)	Nominal current (A)	Order number
orange	24 V AC/DC	+/- 10 %	0,120	875 061 405
	110-120 V AC	+/- 10 %	0,065	875 061 310
	230-240 V AC	+/- 10 %	0,065	875 061 313
red	24 V AC/DC	+/- 10 %	0,120	875 062 405
	110-120 V AC	+/- 10 %	0,065	875 062 310
	230-240 V AC	+/- 10 %	0,065	875 062 313
clear	24 V AC/DC	+/- 10 %	0,120	875 064 405
	110-120 V AC	+/- 10 %	0,065	875 064 310
	230-240 V AC	+/- 10 %	0,065	875 064 313
blue	24 V AC/DC	+/- 10 %	0,120	875 065 405
	110-120 V AC	+/- 10 %	0,065	875 065 310
	230-240 V AC	+/- 10 %	0,065	875 065 313
green	24 V AC/DC	+/- 10 %	0,120	875 066 405
	110-120 V AC	+/- 10 %	0,065	875 066 310
	230-240 V AC	+/- 10 %	0,065	875 066 313
yellow	24 V AC/DC	+/- 10 %	0,120	875 067 405
	110-120 V AC	+/- 10 %	0,065	875 067 310
	230-240 V AC	+/- 10 %	0,065	875 067 313



AMK



AB1



AG1



AKV

ACCESSORIES

Type	Type of accessory	Weight	Order number
AMK	Mounting set for combining several pieces of signalling equipment of the same size	10 g	874 010 900
AB1	Mounting set for metal bracket for mounting in any direction (e.g. on mounting platforms)		874 031 900
AG1	Flat seal for correct IP66 installation on smooth surfaces		874 021 900
AKV	Cable gland M20x1,5		698 800 026

TONE TABLE

STAGE 1 S1	Tone type	Frequency Hz	Pictogram	Repeat rate	Specific Application	max dB
Tone 01	continuous	4600 Hz				103
Tone 02	continuous	1600 Hz				99
Tone 03	intermittent	4600 Hz		250 ms on, 250 ms off		103
Tone 04	intermittent	1600 Hz		250 ms on, 250 ms off		99
Tone 05	sweeping	1200 - 500 Hz		1 Hz	evacuation Germany DIN 33404-3	96
Tone 06	sweeping	500 - 1200 Hz		rising in 3 s, 0.5 s off	Netherlands NEN 2575:2000	98
Tone 07	alternating	800 - 1000 Hz		2 Hz		94
Tone 08	sweeping	500 - 1500 Hz		10 Hz		94
					LED continuous	—



Electronic