



## Doors, Gates & Windows

Sensor technology for safety and convenience.

## **Safety and comfort: Perfect self-assembly with our sensor profile series**

Modern building technology without automatically controlled doors, gates and windows is no longer conceivable. This is true of industrial, commercial and residential buildings. Automation is therefore a definite growth market in this sector.

Depending on the installation situation and the particular use, there is a potential danger to people and objects during the closing movement. Mayser offers pressure-sensitive protection devices that respond quickly to provide reliable protection in danger zones regardless of interfering factors such as incidence of light, dirty surfaces or weather factors. The goal is to provide maximum protection in a user-friendly design. Different contact elements are used depending on the particular areas of application:

- Sensor profiles
- Safety edges
- Miniature safety edges

The new series of sensor profiles developed by Mayser makes DIY solutions even easier for our customers. The company's long-term and broad experience in the area of pressure sensitive sensors, in-house development departments, broad vertical range of manufacture, and competent advice from acknowledged specialists make it possible for us to produce premium quality safety edges.

Electrically operated doors and windows are also considered machines in accordance with the Machinery Directive and are subject to special safety requirements. Safety components from Mayser are tested in accordance with EN 12978 and/or EN ISO 13849 and/or EN ISO 13856 and thus comply with the safety-related requirements of the Machinery Directive.



## Table of contents

<b>1</b>	<b>Areas of application</b>	<b>4</b>
	Sliding gates	4
	High-speed folding gates	4
	High-speed doors / overhead sectional doors/ roller gates	4
	Barriers	5
	Louvred windows	5
	Revolving doors	5
<b>2</b>	<b>Our solutions</b>	<b>6</b>
	Sensor profiles	6
	Safety edges	7
	Miniature safety edges	7
<b>3</b>	<b>Sensor profiles</b>	<b>8</b>
	The most important characteristics	8
	Technical data	9
<b>4</b>	<b>DIY sensor profiles</b>	<b>10</b>
<b>5</b>	<b>Miniature safety edges</b>	<b>12</b>
	Technical data	12
	The most important characteristics	13
<b>6</b>	<b>Signal transmission</b>	<b>14</b>
	Wireless signal transmission via radio	14
	Transmission via cable	15
<b>7</b>	<b>Profile overview</b>	<b>16</b>
<b>8</b>	<b>Miniature safety edges EKS</b>	<b>18</b>

# 1 Areas of application

Mayser pressure-sensitive protection devices provide reliable protection at main and secondary closing edges of doors, gates or windows that close automatically. If a person or an object is in the danger zone during the closing movement of the door or gate, a pressure-sensitive sensor is actuated. The control system stops or reverses the automatic closing motion.

Our pressure-sensitive protection devices for main and secondary closing edges are used in the following areas:

- Sliding gates
- High-speed folding gates
- High-speed doors
- Overhead sectional doors
- Roller gates
- Barriers
- Doors
- Louvred windows
- Revolving doors

The new series of sensor profiles was specially developed for your sector of industry and is therefore custom tailored to the requirements of the door and gate market. In-house development of tools and profile geometries means that Mayser can guarantee optimal product properties.

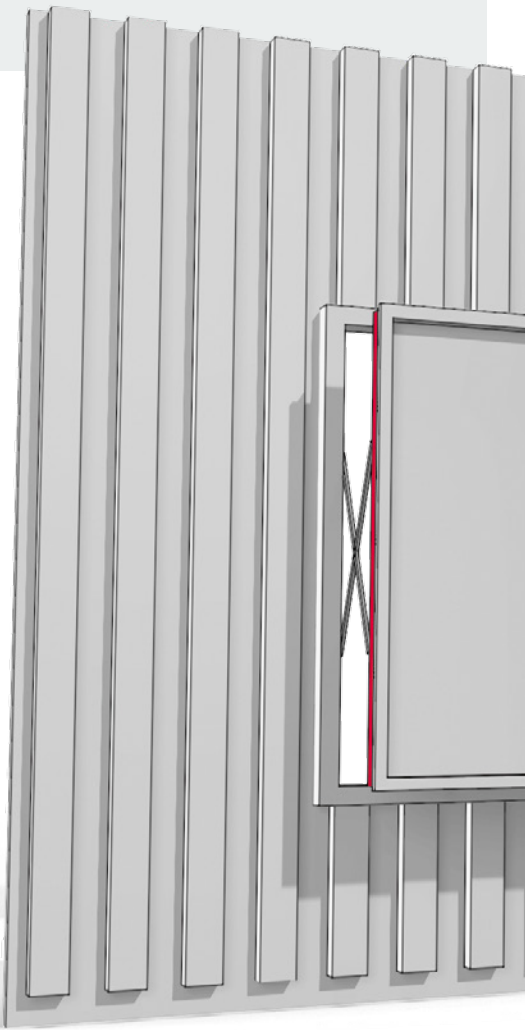

◆ Pressure sensitive sensors

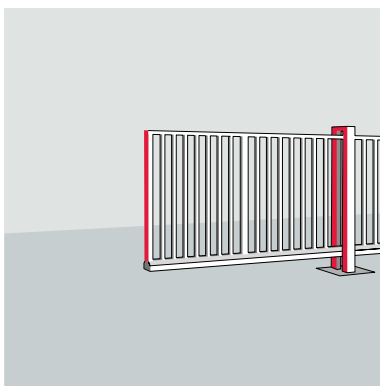

Sliding gates

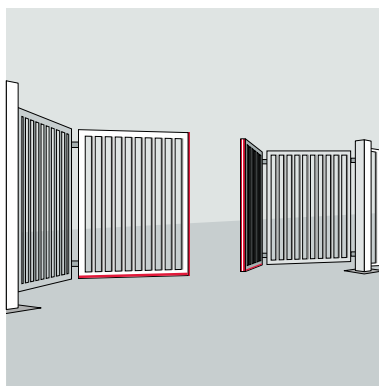

High-speed folding gates



High-speed doors/  
overhead sectional  
doors/roller gates

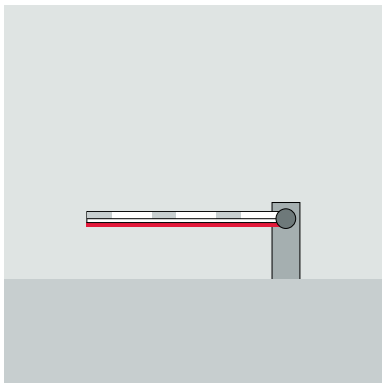
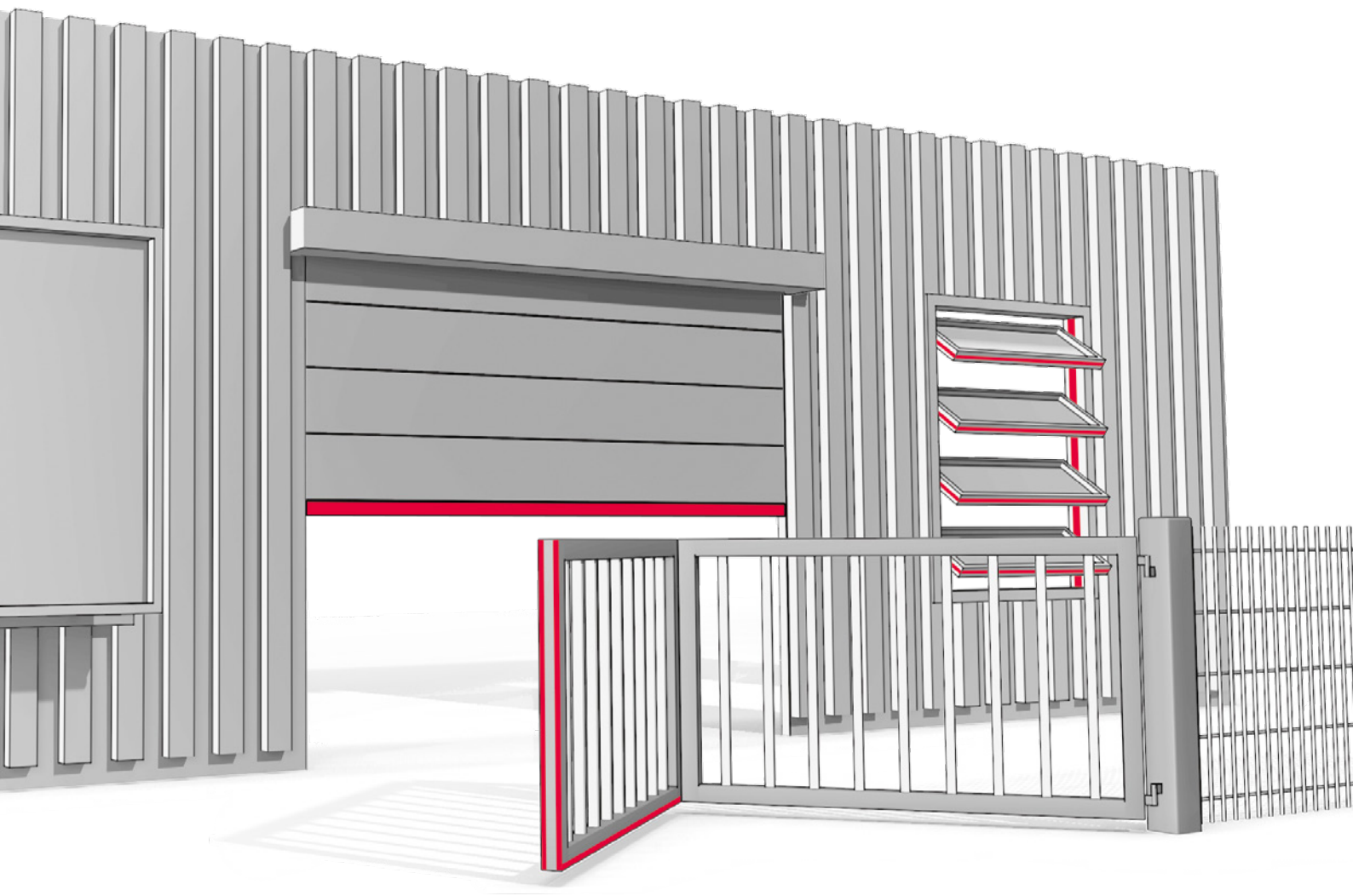

Barriers

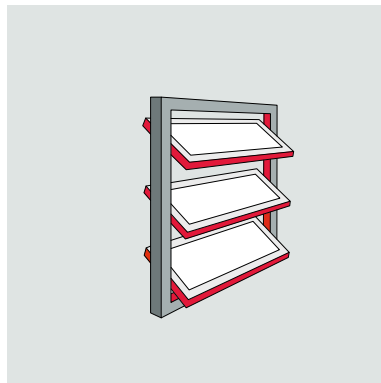

Louved windows

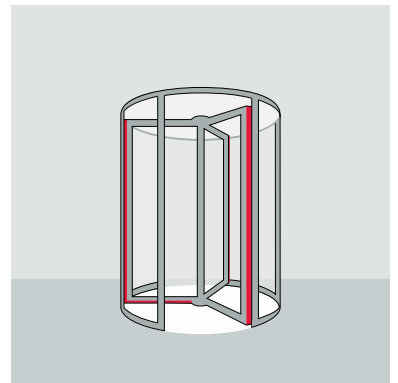

Revolving doors

## 2 Our solutions



### Sensor profiles



The sensor profile series SP for protecting closing edges is available individually adapted to your products or, on request, as a DIY solution. Whether for use in production or uncomplicated on-site servicing, DIY installation of the new sensor profile series is very fast and requires no additional tools.

A smart plug-in system consisting of the sensor, plug and a cap allows fast and easy installation of functioning safety edges directly at the gate with IP67 protection without the use of adhesives.



◆ Pressure sensitive sensors



## Safety edges

Safety edges consist of an inner safety element with a rubber envelope profile. You can choose from diverse profile geometries, as well as custom versions with special bending radii, angled geometries and active ends.

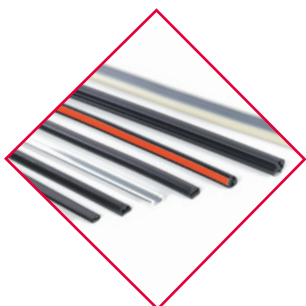

## Miniature safety edges

Miniature safety edges are custom tailored to the requirements of power-operated windows. They adapt discreetly to the design of the window geometry.

## 3 Sensor profiles

Our sensor profiles are coextrusion profiles consisting of elastomer components with different properties. This design enables versatile and user-friendly handling that is advantageous for the protection of doors and gates. Mayser offers its customers an above-average selection of base geometries, profile sections and colours. This broad product spectrum makes the profiles ideal for large-scale commercial and industrial use. We can also implement individual customer requirements, including printing of the profiles.

The sensor profiles withstand extreme loads, are manufactured for a custom fit, feature a non-slip and sturdy design, and must pass stringent quality controls. All profiles are subjected to extensive environmental and endurance testing and have a B10<sub>D</sub> of at least 2 million test cycles.

### The most important characteristics

- ✓ Absolutely dust-proof to provide complete contact protection
- ✓ Extremely resistant to hot and cold temperatures
- ✓ High degree of protection (IP67) Protection against temporary immersion (1m water column >30 minutes)
- ✓ Low switching force
- ✓ Short actuation distances
- ✓ Long overtravel distance
- ✓ DIY plug has a very high pull-out force
- ✓ Testing basis: EN 12978, ISO 13849-1, ISO 13856-2
- ✓ Compatible with conventional gate control systems and transmission systems – 8K2 evaluation



Even DIY sensor profiles offer protection against dust and water according to protection class IP67. On request, we also supply a DIY version with protection class IP68.

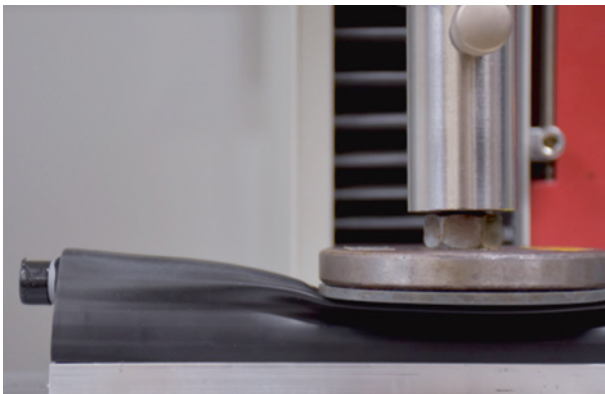



## Technical data

	<b>Sensor profiles</b>
Operation	Pressure-sensitive NO contact principle
Overall height	20 – 120 mm
Actuation angle	±45° to ±50°
DIY	•
Applied standards	EN 12978 ISO 13856-2 ISO 13849-1
Degree of protection	IP67 / Higher protection classes on request
Operating temperature	Min. -25°C max. +55°C
Actuation distance	5 – 10 mm at 100 mm/s depending on profile
Overtravel distance	1.4 – 52 mm depending on profile
Material	TPE



## 4 DIY sensor profiles

Even easier than before: DIY installation of the new sensor profile series. The smart plug-in system – sensor/plug/cap – enables fast assembly in production or during on-site servicing in just three steps. Practically without tools.

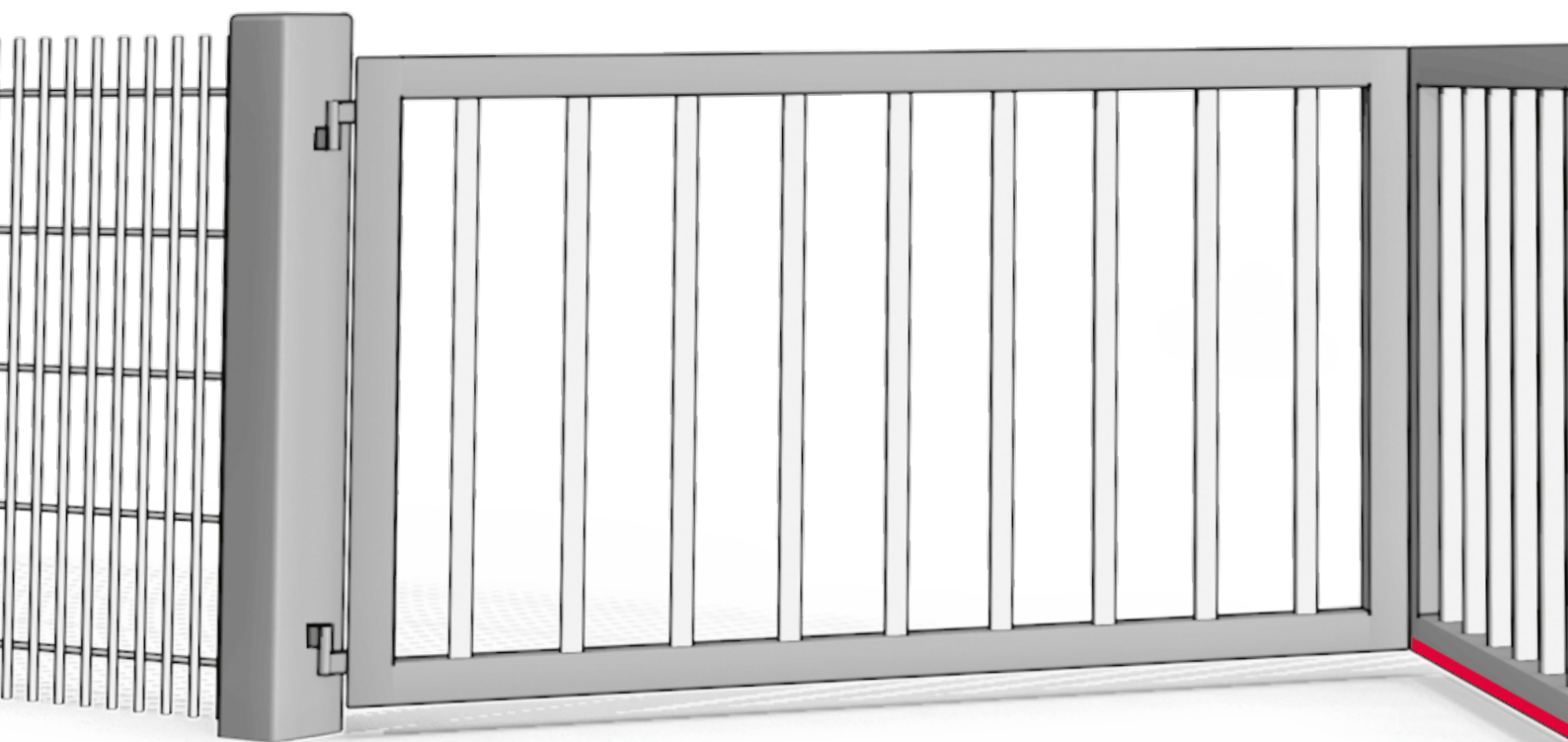

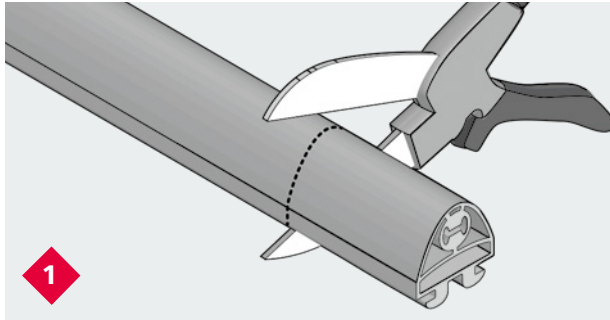

Cut off profile / rail

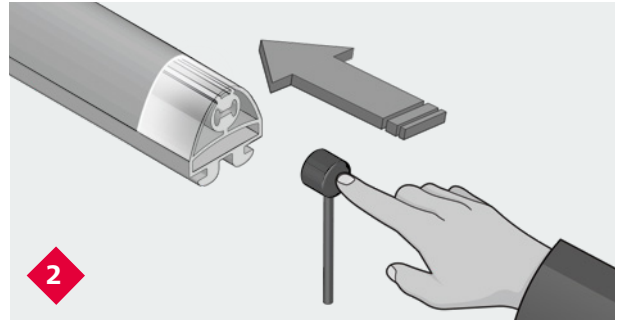

Plug in sensor / resistor

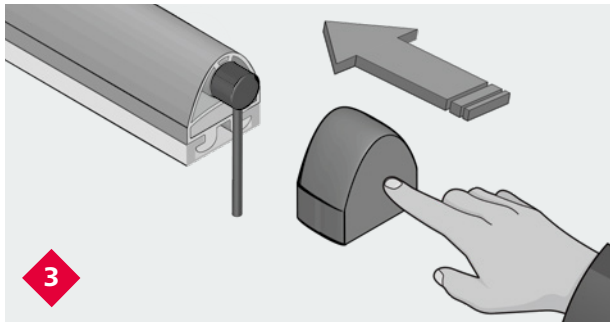

Insert rubber profile / put on end cap

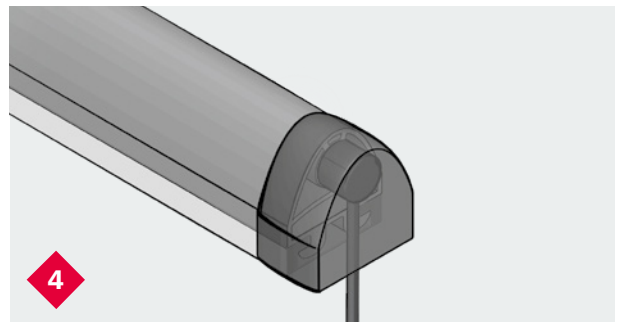
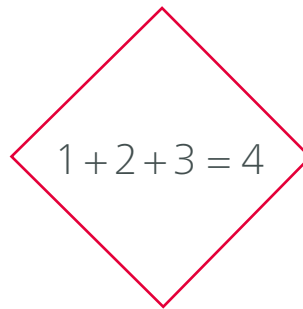

Finished sensor profile

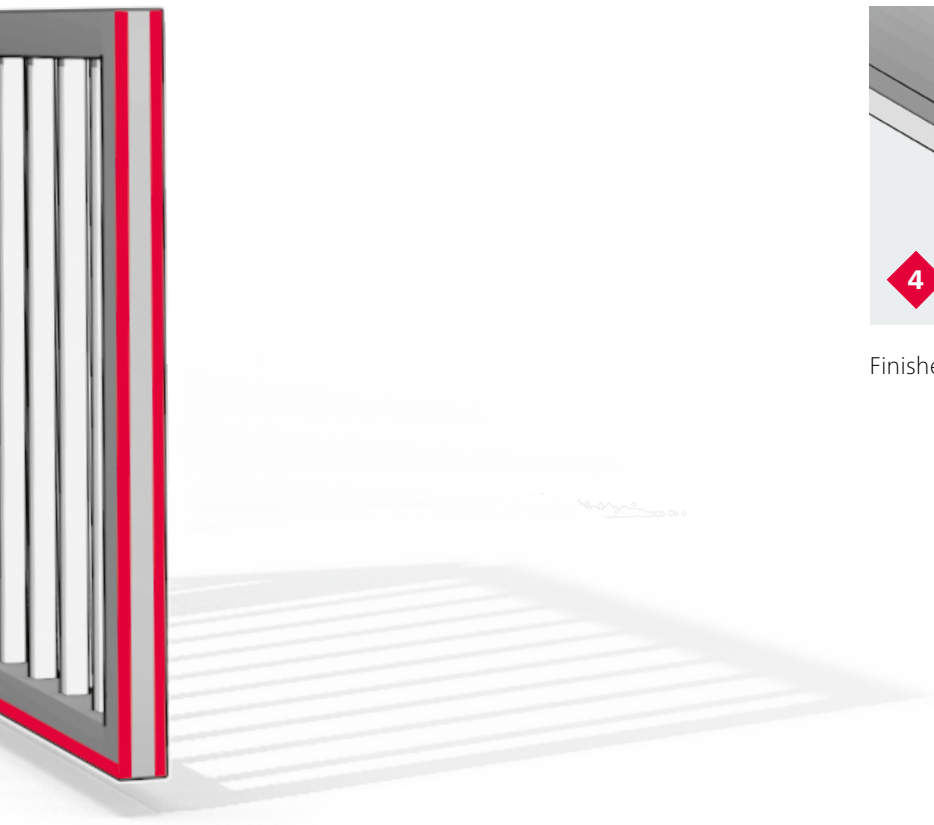

## 5 Miniature safety edges

Miniature safety edges are specially developed for low overtravel distances and minimal installation heights. They are especially suitable for use in window and façade technology to protect fingers from being pinched. If the sensor comes into contact with an obstacle while a window is closing, the system immediately stops the closing motion and the window opens again. Miniature safety edges can easily be adapted to different bending radii and angles. For indoor use you can prepare the anti-pinch sensor yourself.

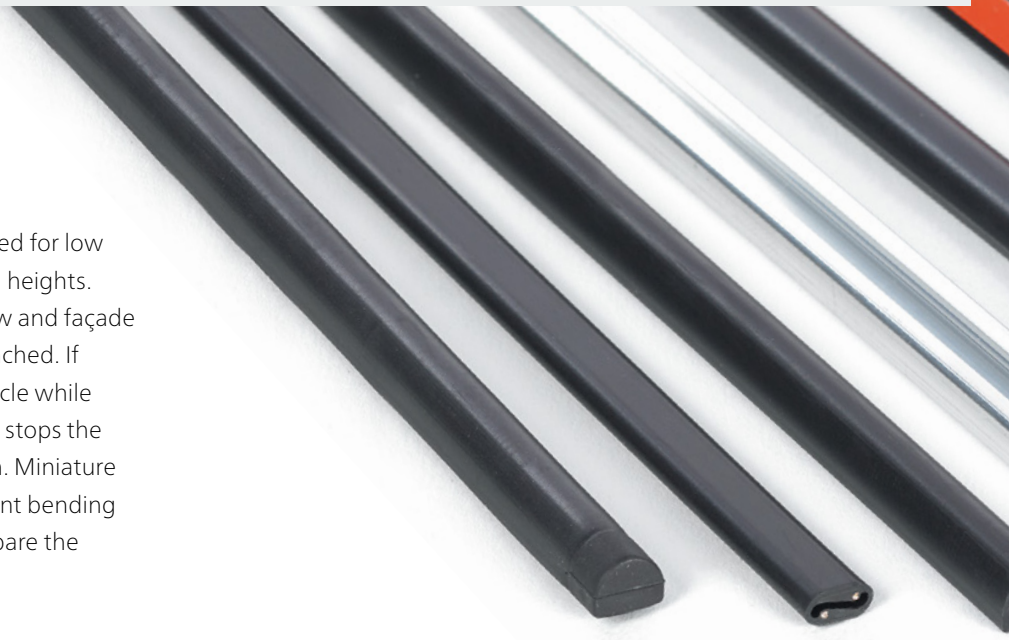

### Technical data

	<b>Miniature safety edge / anti-pinch sensor</b>
Operation	Pressure-sensitive NO contact principle
Overall height	4 – 16 mm
Actuation angle	Up to $\pm 45^\circ$
DIY	•
Applied standards	ISO 13849-1 ISO 13856-2
Degree of protection	IP65
Operating temperature	Min. $-25^\circ\text{C}$ max. $+80^\circ\text{C}$
Actuation distance	$\leq 1.0$ mm
Material	TPE
Custom adaptation	Bend radii Angled geometries



## The most important characteristics

- ✓ Tested according to EN ISO 13849-1 and ISO 13856-2
- ✓ High sensitivity – short reaction time
- ✓ Ideal for low installation heights
- ✓ Diverse profile geometries
- ✓ Versatile profile mounting options
- ✓ Temperature-insensitive (–40°C to +85°C)
- ✓ Profiles available for tight bending radii



All of our safety edges and miniature safety edges are maintenance-free.

## 6 Signal transmission

### Radio transmission system

Our function transmission system offers the perfect solution for all automatic doors and gates fitted with safety edges. It replaces conventional cable or transponder systems for signal transmission. The signals triggered by the safety edge are transmitted to the motor control system of the door or gate drive. The system is compatible with all motor control systems and stands out for its long range.

### The most important characteristics

#### Transmitter

- ✓ Multi-frequency system – four self-setting channels
- ✓ One transmitter controls two safety edges
- ✓ 50 metres usable range, 100 metres nominal range (open field)
- ✓ Operating temperature  $-20^{\circ}\text{C}$  to  $+55^{\circ}\text{C}$
- ✓ Protection class IP65



#### Receiver

- ✓ Capacity for six transmitters
- ✓ Transmission power 25 mW
- ✓ Operating temperature  $-20^{\circ}\text{C}$  to  $+55^{\circ}\text{C}$
- ✓ 50 metres usable range, 100 metres nominal range (open field)
- ✓ Protection class IP65 (IP65 with cable screw connection)

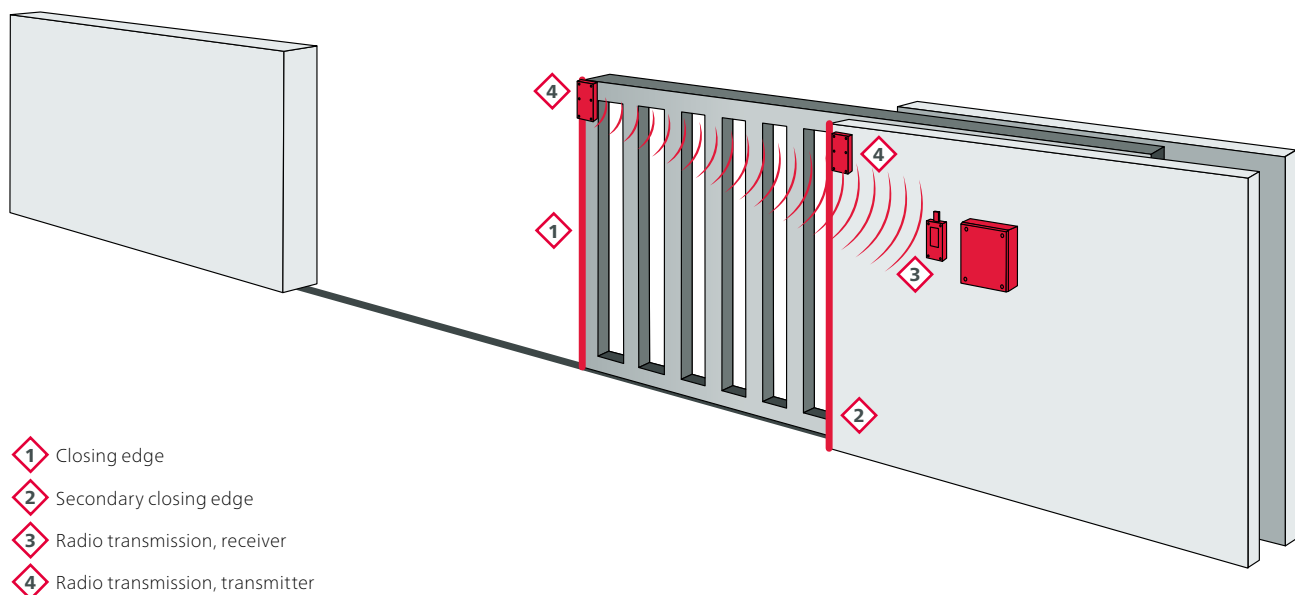

- 1 Closing edge
- 2 Secondary closing edge
- 3 Radio transmission, receiver
- 4 Radio transmission, transmitter

## Spiral cable systems (WLS)

The spiral cable system (WLS) is used as a protected cable conduit for gates and systems. The system is used especially for safe signal transmission between tactile sensors e.g. safety edges and the drive control in safeguarding danger zones. It consists of a slotted aluminium profile conduit and a spiral cable which is tailored to the cable, as well as friction-proof and extremely dimensionally stable, plus a conduit carriage.

When the carriage moves, the cable inside the profile conduit is extended, and when the carriage returns, the cable goes back to its original length. The coordinated components allow indoor and outdoor use and are also suitable for gate systems in high-frequency operation.



### The most important characteristics

- ✓ Fast installation
- ✓ Maintenance-free
- ✓ Operating temperature  $-20^{\circ}\text{C}$  to  $+80^{\circ}\text{C}$
- ✓ Short signal transmission times to comply with dynamic power and time parameters
- ✓ Runway 1.5 m up to max. 23.5 m
- ✓ Running speed 40 m/min

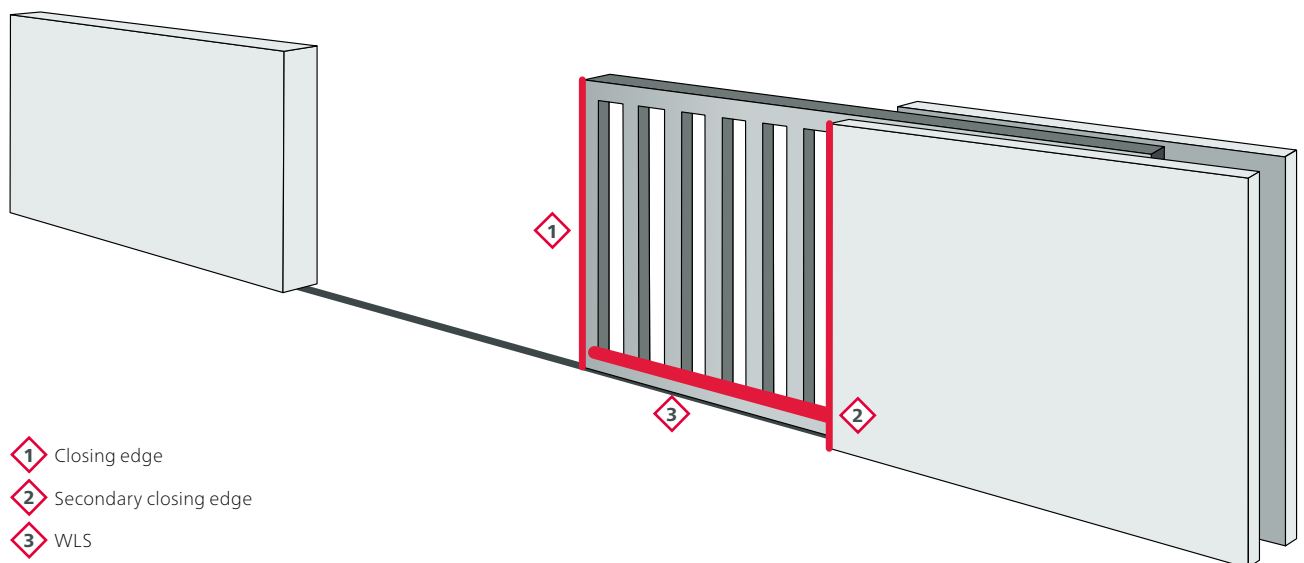

- 1 Closing edge
- 2 Secondary closing edge
- 3 WLS

## 7 Overview of profiles



Designation	SP 17-3	SP 37-1	SP 37-2	SP 37-3
Art. no.	7503461	7502853	7503318	7503343
Mounting	Snap-in foot	Snap-in foot	Snap-in web	T-foot
Roller size	80 mm	30 mm	30 mm	30 mm

### Profile geometries

Height	20.3 mm	37.5 mm	38 mm	38 mm
Width	15.5 mm	25 mm	25 mm	25 mm

### Speed 10 mm/s

Actuation force	38 N	42 N	42 N	42 N
Response time	140 ms	580 ms	580 ms	580 ms
Actuation distance	1.4 mm	5.8 mm	5.8 mm	5.8 mm
Overtravel distance up to:				
250 N	1.4 mm	9.2 mm	9.2 mm	9.2 mm
400 N	2.3 mm	11.1 mm	11.1 mm	11.1 mm
600 N	4.1 mm	13.0 mm	13.0 mm	13.0 mm
Total deformation	5.5 mm	18.8 mm	18.8 mm	18.8 mm

### Speed 100 mm/s

Actuation force	-	50 N	50 N	50 N
Response time	-	58 ms	58 ms	58 ms
Actuation distance	-	5.8 mm	5.8 mm	5.8 mm
Overtravel distance up to:				
250 N	-	8.7 mm	8.7 mm	8.7 mm
400 N	-	10.5 mm	10.5 mm	10.5 mm
600 N	-	12.5 mm	12.5 mm	12.5 mm
Total deformation	-	18.3 mm	18.3 mm	18.3 mm

### Speed 200 mm/s

Actuation force	-	54 N	54 N	54 N
Response time	-	35 ms	35 ms	35 ms
Actuation distance	-	7.0 mm	7.0 mm	7.0 mm
Overtravel distance up to:				
250 N	-	3.8 mm	3.8 mm	3.8 mm
400 N	-	7.6 mm	7.6 mm	7.6 mm
600 N	-	12.9 mm	12.9 mm	12.9 mm
Total deformation	-	19.9 mm	19.9 mm	19.9 mm



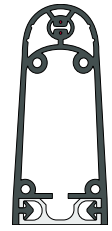
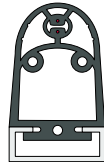
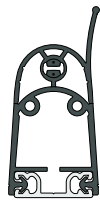
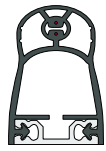

<b>SP 57-2</b> 7503055	<b>SP 57L-2</b> 7503412	<b>SP 57-3</b> 7503521	<b>SP 57L-4</b> 7503711	<b>SP 67-2</b> 7503285	<b>SP 87-2</b> 7503722
Snap-in web	Snap-in web	T-foot	T-foot	Snap-in web	Snap-in web
30 m	30 m	25 m	25 m	25 m	25 m
56 mm	64 mm	64 mm	79 mm	67.3 mm	87 mm
34 mm	34 mm	35 mm	35 mm	34 mm	36.3 mm
48 N	48 N	48 N	48 N	41 N	34 N
910 ms	910 ms	910 ms	910 ms	880 ms	850 ms
9.1 mm	9.1 mm	9.1 mm	9.1 mm	8.8 mm	8.5 mm
24.5 mm	24.5 mm	24.5 mm	24.5 mm	35.7 mm	52.3 mm
29.3 mm	29.3 mm	29.3 mm	29.3 mm	37.9 mm	54.7 mm
31.0 mm	31.0 mm	31.0 mm	31.0 mm	41.0 mm	56.2 mm
40.1 mm	40.1 mm	40.1 mm	40.1 mm	49.8 mm	64.7 mm
41 N	41 N	41 N	41 N	42 N	38 N
80 ms	80 ms	80 ms	80 ms	101 ms	81 ms
8.0 mm	8.0 mm	8.0 mm	8.0 mm	10.1 mm	8.1 mm
26.0 mm	26.0 mm	26.0 mm	26.0 mm	35.4 mm	51.9 mm
29.4 mm	29.4 mm	29.4 mm	29.4 mm	37.8 mm	54.4 mm
31.5 mm	31.5 mm	31.5 mm	31.5 mm	39.8 mm	56.0 mm
39.5 mm	39.5 mm	39.5 mm	39.5 mm	49.9 mm	64.1 mm
58 N	58 N	58 N	58 N	45 N	37 N
71 ms	71 ms	71 ms	71 ms	51.5 ms	47 ms
14.2 mm	14.2 mm	14.2 mm	14.2 mm	10.3 mm	9.4 mm
20.8 mm	20.8 mm	20.8 mm	20.8 mm	36.5 mm	51.5 mm
23.7 mm	23.7 mm	23.7 mm	23.7 mm	39.4 mm	54.0 mm
25.9 mm	25.9 mm	25.9 mm	25.9 mm	41.3 mm	55.5 mm
40.1 mm	40.1 mm	40.1 mm	40.1 mm	51.6 mm	64.9 mm

## 8 Miniature safety edges EKS

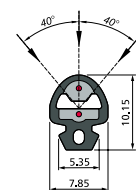
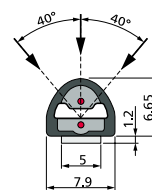
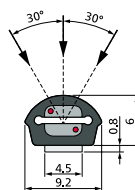
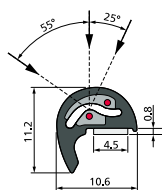

<b>Designation</b>	<b>EKS 001</b>	<b>EKS 002</b>	<b>EKS 011</b>	<b>EKS 014</b>
--------------------	----------------	----------------	----------------	----------------

### Safety classifications

ISO 13849-1: B <sub>10D</sub>	2 x 10 <sup>6</sup>	2 x 10 <sup>6</sup>	2 x 10 <sup>6</sup>	2 x 10 <sup>6</sup>
-------------------------------	---------------------	---------------------	---------------------	---------------------

### Switching characteristics

Switching operations	10.000	10.000	10.000	10.000
Actuation force	+23°C < 15 N	+23°C < 10 N	+23°C < 15 N	+23°C < 15 N
Test piece (rod) Ø 4 mm	< 30 N	< 20 N	< 25 N	< 25 N
Test sample Ø 200 mm				
Actuation distance	< 2.0 mm	< 1.5 mm	< 2.0 mm	< 2.0 mm
Test piece (cylinder) Ø 80 mm				
Actuation angle	+55° / -25°	± 30°	± 40°	± 40°
Test piece (cylinder) Ø 80 mm				

### Mechanical operating conditions

Material	TPE	TPE	TPE	TPE
Weight	54 g/m	45 g/m	43 g/m	49 g/m / 125 g/m (with / without C10)
Sensor length (min./max.)	300 mm / 140 m	70 mm / 150 m	70 mm / 150 m	70 mm / 140 m
Cable length (min./max.)	100 mm / 200 m	100 mm / 200 m	100 mm / 200 m	100 mm / 200 m
Mounting by peel force	Acrylic Foam 15 N/cm	Acrylic Foam 15 N/cm	Acrylic Foam 15 N/cm	Snap-in foot
IEC 60529: protection class	IP67	IP67	IP67	IP67
Operating temperature briefly (15 min)	-25° to +80°C -40° to +100°C	-25° to +80°C -40° to +100°C	-25° to +80°C -40° to +100°C	-25° to +80°C -40° to +100°C
Bend radii, minimum (B1 / B2 / B3 / B4)	60 / 70 / 80 / 80 mm	60 / 70 / 80 / 80 mm	120 / 150 / 20 / 20 mm	120 / 150 / 20 / 20 mm

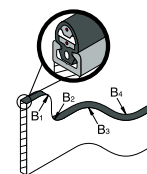
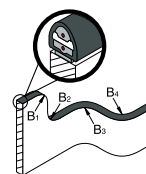
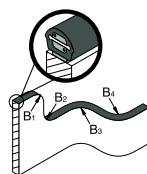
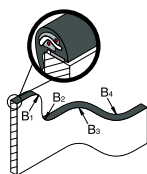

### Electrical operating conditions

Terminal resistance (± 1%) Nominal output (max.)	8k2 250 mW	8k2 250 mW	8k2 250 mW	8k2 250 mW
Contact transition resistance	< 400 ohms (per sensor)	< 400 ohms (per sensor)	< 400 ohms (per sensor)	< 400 ohms (per sensor)
Number of BK-type sensors	Max. 5 in series	Max. 5 in series	Max. 5 in series	Max. 5 in series
Switching voltage (max.)	DC 24 V	DC 24 V	DC 24 V	DC 24 V
Switching current (min./max.)	1 mA / 10 mA	1 mA / 10 mA	1 mA / 10 mA	1 mA / 10 mA
Connection cable	2 wires, each Ø 1.4 mm TPE 2 x 0.35 mm <sup>2</sup>	Ø 3.7 mm TPE 2 x 0.22 mm <sup>2</sup>	Ø 3.7 mm TPE 2 x 0.22 mm <sup>2</sup>	Ø 3.7 mm TPE 2 x 0.22 mm <sup>2</sup>

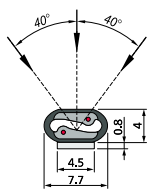

**EKS 026**

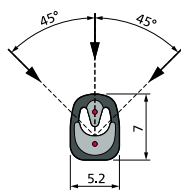

**EKS 027**

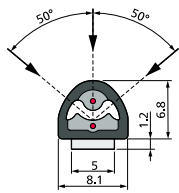

**EKS 030-2**

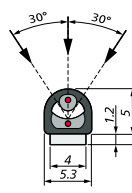

**EKS 035-2**

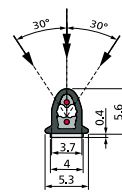

**EKS 038**

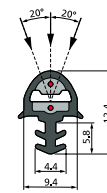

**EKS 052**

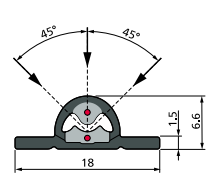

**EKS 055**

2 x 10 <sup>6</sup>	2 x 10 <sup>6</sup>	2 x 10 <sup>6</sup>	2 x 10 <sup>6</sup>	2 x 10 <sup>6</sup>	2 x 10 <sup>6</sup>	2 x 10 <sup>6</sup>
10.000	10.000	10.000	10.000	10.000	10.000	10.000
+23°C < 10 N < 15 N	+23°C < 15 N < 25 N	+23°C < 15 N < 20 N	+23°C < 15 N < 20 N	+23°C < 10 N < 15 N	+23°C < 15 N < 25 N	+23°C < 15 N < 20 N
< 1.0 mm	< 2.0 mm	< 2.0 mm	< 2.0 mm	< 1.0 mm	< 1.0 mm	< 2.0 mm
± 40°	± 45°	± 50°	± 30°	± 30°	± 20°	± 45°
TPE	TPE	TPE	TPE	TPE	TPE	TPE
25 g/m	29 g/m	44 g/m	25 g/m	54 g/m	54 g/m	55 g/m
70 mm / 150 m	70 mm / 150 m	70 mm / 150 m	70 mm / 150 m	70 mm / 150 m	200 mm / 130 m	200 mm / 130 m
100 mm / 200 m	100 mm / 200 m	100 mm / 200 m	100 mm / 200 m	100 mm / 200 m	100 mm / 200 m	100 mm / 200 m
Acrylic Foam 15 N/cm	Insert profile	Acrylic Foam 15 N/cm	Acrylic Foam 15 N/cm	Acrylic Foam 15 N/cm	Clamp foot	Wing
IP67	IP67	IP67	IP67	IP67	IP67	IP67
-25° to +80°C -40° to +100°C	-25° to +80°C -40° to +100°C	-25° to +80°C -40° to +100°C	-25° to +80°C -40° to +100°C	-25° to +80°C -40° to +100°C	-25° to +80°C -40° to +100°C	-25° to +80°C -40° to +100°C
80 / 50 / 120 / 120 mm	120 / - / 20 / 20 mm	800 / 1000 / 200 / 200 mm	800 / 1000 / 200 / 200 mm	500 / 300 / 15 / 15 mm	120 / 150 / 20 / 20 mm	70 / 60 / 150 / 150 mm
8k2 250 mW	8k2 250 mW	8k2 250 mW	8k2 250 mW	8k2 250 mW	8k2 250 mW	8k2 250 mW
< 400 ohms (per sensor)	< 400 ohms (per sensor)	< 400 ohms (per sensor)	< 400 ohms (per sensor)	< 400 ohms (per sensor)	< 400 ohms (per sensor)	< 400 ohms (per sensor)
Max. 5 in series	Max. 5 in series	Max. 5 in series	Max. 5 in series	Max. 5 in series	Max. 5 in series	Max. 5 in series
DC 24 V	DC 24 V	DC 24 V	DC 24 V	DC 24 V	DC 24 V	DC 24 V
1 mA / 10 mA	1 mA / 10 mA	1 mA / 10 mA	1 mA / 10 mA	1 mA / 10 mA	1 mA / 10 mA	1 mA / 10 mA
2 wires, each Ø 1.4 mm TPE 2 x 0.35 mm <sup>2</sup>	Ø 4.1 mm TPE 2 x 0.35 mm <sup>2</sup>	Ø 3.7 mm TPE 2 x 0.22 mm <sup>2</sup>	Ø 3.7 mm TPE 2 x 0.22 mm <sup>2</sup>	2 wires, each Ø 1.4 mm TPE 2 x 0.35 mm <sup>2</sup>	Ø 3.7 mm TPE 2 x 0.22 mm <sup>2</sup>	Ø 3.7 mm TPE 2 x 0.22 mm <sup>2</sup>

The technical data is applicable as of the date of printing. Technical specifications, design and features are subject to change without notice, due to continued development at Mayser – errors excepted. Illustrations are not binding and may contain options.

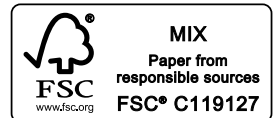

[www.mayser.com](http://www.mayser.com)

**Mayser GmbH & Co. KG**

Bismarckstraße 2  
88161 Lindenberg  
GERMANY

Phone: +49 8381 507-0  
[info.lindenberg@mayser.com](mailto:info.lindenberg@mayser.com)

**Mayser GmbH & Co. KG**

Örlinger Straße 1–3  
89073 Ulm  
GERMANY

Phone: +49 731 2061-0  
[info.ulm@mayser.com](mailto:info.ulm@mayser.com)

**Mayser USA, Inc.**

6200 Schooner Drive  
48111 Belleville /  
Michigan  
USA

Phone: +1 734 858-1290  
[usa@mayser.com](mailto:usa@mayser.com)

**Mayser France**

Les Aunettes  
12M Bd. Louise Michel  
91030 Evry Cedex  
FRANCE

Phone: +33 1 6077-3637  
[france@mayser.com](mailto:france@mayser.com)

**Mayser Slovakia s.r.o.**

Gemerska 564  
04951 Brzotin  
SLOVAKIA

Phone: +421 58-7884870  
[roznava@mayser.com](mailto:roznava@mayser.com)

