



Split Core Low Power Current Transformer

CT24-SC-010-200-50/333mV, Cl.0.5

CT24-SC-010-025-50/333mV, Cl.0.5

Data sheet

Doc. no. 2.353.080.1.d 11/2023

TECHNICAL DATA & DIMENSIONS

Type	Cable length	Primary current	Item number
CT24-SC-010-200-50/333mV, Cl.0.5	2.0 m (78.74 in)	50 A	1503124
CT24-SC-010-025-50/333mV, Cl.0.5	0.25 m (9.84 in)	50 A	1503127

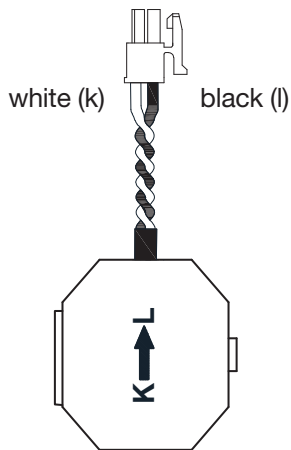
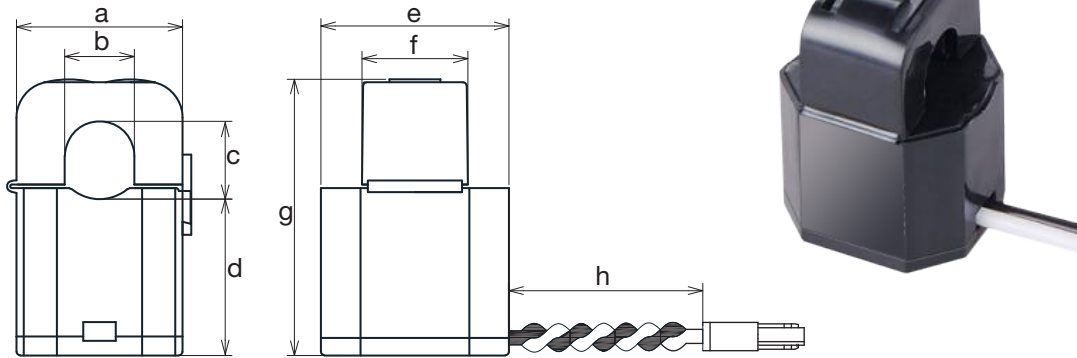

Letter	Length in mm	Length in inch
a	23.5 ±0.5	0.93 ±0.02
b	10 ±0.3	0.39 ±0.01
c	10.2	0.40
d	22.5	0.89
e	26.5 ±0.5	1.04 ±0.02
f	14.5	0.57
g	39 ±0.5	1.535 ±0.02
h	Art. No. 1503124	2000 ±50
	Art. No. 1503127	250 ±20

Specifications		Data
Primary current		50 A
Weight appr.	Art. No. 1503124	55 g (0.12 lb)
	Art. No. 1503127	40 g (0.09 lb)
Output signal		333 mV
PVC wire leads		24 AWG
Accuracy class		0.5
Frequency		50 - 60 Hz
Insulation resistance		DC 500 V/100 M Ω min
Operating temperature		-40 °C bis 65 °C (-40 °F bis 149 °F)
Storage temperature		-45 °C bis 80 °C (-49 °F bis 176 °F)
Standards		ANSI C57.13, IEC61869-2, RoHS compliant
Case		Solid housing with durable plastic UL 94 V-0
Dielectric strength		2.5 kV/1mA/1min

CONNECTION

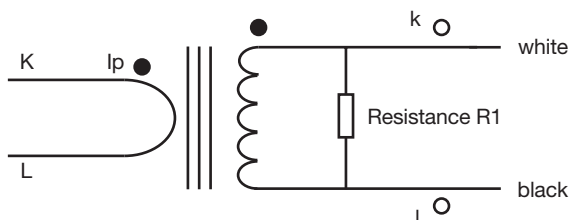

Janitza[®]

Janitza electronics GmbH
Vor dem Polstück 6 | 35633 Lahnau
Germany

Tel. +49 6441 9642-0
info@janitza.com | www.janitza.com