

Ethernet



Modbus-Ethernet gateway



Memory 32 MB



Pulse inputs and
Pulse outputs



Thermistor input



Threshold value monitoring



Smart and compact:

Save energy costs through the universal data logger

- Basis for a comprehensive energy management system (ISO 50001)
- Mapping of all consumption and process data (current, water, gas, steam, pressure, etc.)
- Monitoring of switching statuses (e.g. circuit breaker, etc.)
- Analysis of energy consumption and operating hours
- Flexible integration in superordinate systems (Modbus-Ethernet gateway)
- Long-term storage of data with 32 MB onboard memory
- Saving of 24 differential monthly energy values as well as maximum power values - for each of the fifteen individual inputs on board
- Direct reading out and analysis of data via GridVis® software
- Free programming of 64 independent weekly timers
- Tariff conversion: Each digital input can be assigned a selected tariff from 1 to 8

Universal data logger for all consumption media

- 15 digital / pulse inputs
- 3 digital outputs, switchable via Modbus, weekly timer, threshold value and temperature monitoring
- Temperature measurement input
- Ethernet interface (ModbusTCP/IP, NTP ...)
- RS485 (Modbus RTU, slave, up to 115 kbps)
- 32 MB flash data memory
- Clock and battery function
- 64 weekly timers
- Threshold value monitoring
- Modbus-Ethernet gateway functionality
- Saving of minimum and maximum values (with time stamp)
- Configurable records, can be read out via RS485 and Ethernet

Applications

- EnMS per ISO 50001
- Integration of previously installed pulse counters in an EnMS
- Logging of non-electrical values
- Generation of performance indicators (key figures)
- Logging and monitoring of status messages
- Generation of alarms
- Ethernet-Modbus-Slave gateway

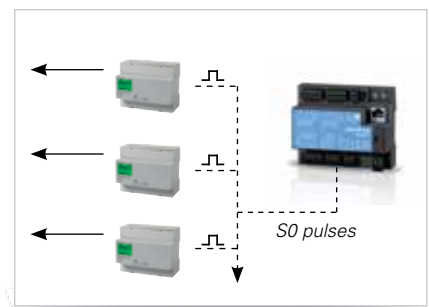

Fig.: Easy integration of existing meters



Fig.: Consolidation of diverse consumption media

Ethernet with gateway functionality

- Communication via Ethernet and Modbus RS485
- Simple integration in the LAN network
- Rapid and reliable data transfer
- Access to measurement data via various channels

Simple integration of existing meters

- Via Modbus-Ethernet Gateway integration and read-out of subordinate Modbus slave devices (e.g. electricity meters) possible with ease
- Conveniently capture measurements from all brands of meter with an S0 pulse output

Well thought-out to the last (vital) detail

- Internal clock generates precise data and time information for records and events
- Permanent operation of the clock thanks to integrated emergency battery
- Battery not permanently installed; as such convenient replacement possible

The ProData is the practical person's favourite

- Wide range power adapter (20 – 250 V AC, 20 – 300 V DC)
- Auto-Baud detection of the communication interface
- Screwable plug-in terminals
- Modbus address easily externally adjustable
- Rapid DIN rail installation

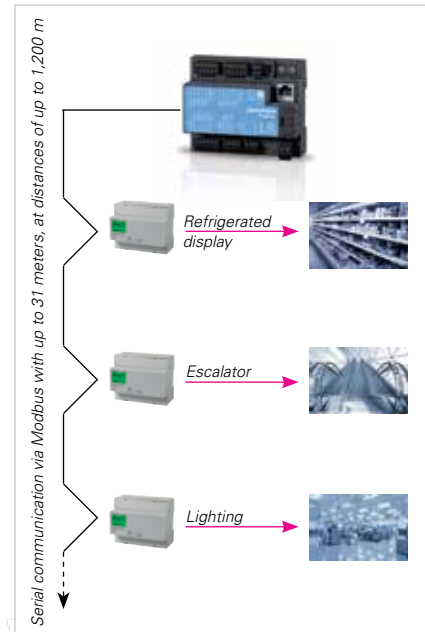

Fig.: Simple consolidation of Modbus meters

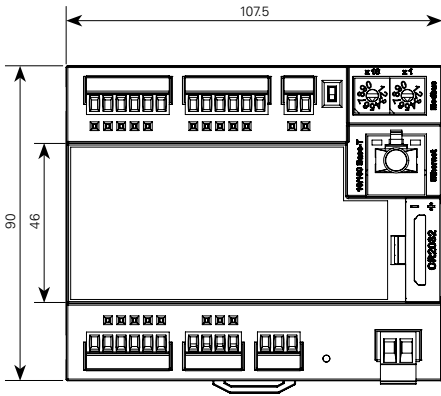

Fig.: Easy exchange of the battery during operation



Dimension diagrams

All dimensions in mm



Front view

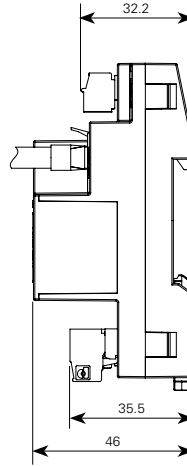

Side view



Typical connection

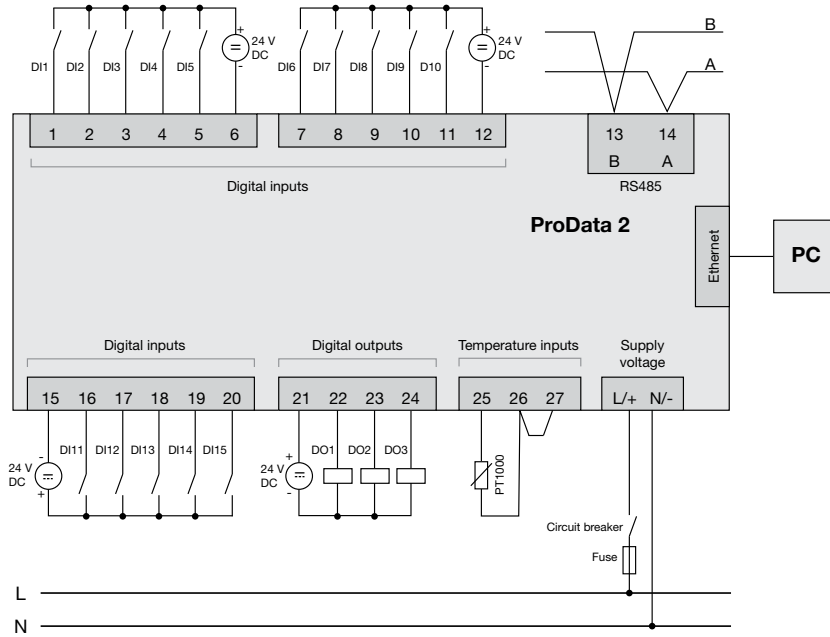



Device overview and technical data

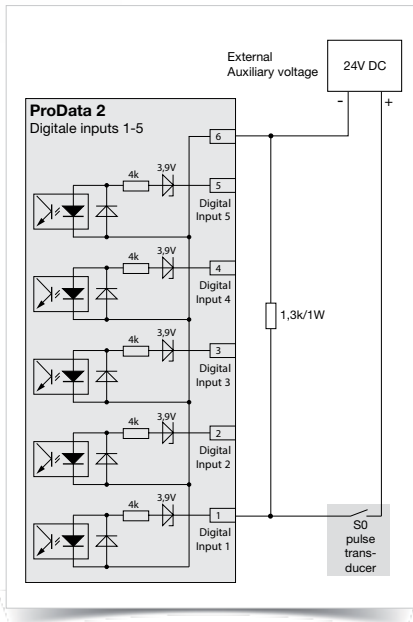

Fig.: S0 pulse input with external supply voltage and external plug-in resistor module*³

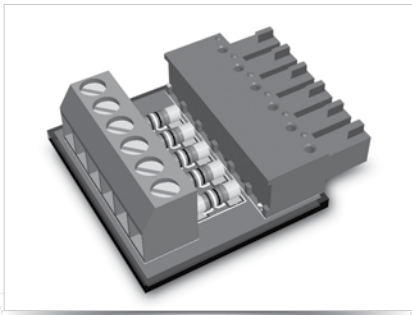

Fig.: S0 plug-in module (item no.: 52.24.111)

Comment: For detailed technical information please refer to the operation manual and the Modbus address list.

• = included - = not included

^{*1} Use as a Modbus RTU slave is not possible in this mode. The ProData is only able to pass on requests to a Modbus slave device; it cannot request Modbus slave devices itself.

^{*2} Optional additional functions with the packages GridVis®-Professional, GridVis®-Enterprise and GridVis®-Service.

^{*3} External resistor S0 plug-in module for connection to an S0 pulse transducer required (item no.: 52.24.111)

ProData	
Item number	52.24.011
Supply voltage	20 – 250 V AC or 20 – 300 V DC
Overvoltage category	300 V CAT II
Power consumption	max. 4 VA / 2 W

General	
Use in low voltage networks	•
Other measurements	
Operating hours measurement	•
Clock	•
Data logging	
Memory (Flash)	32 MB
Mean, minimum, maximum values	•
Alarm messages	•
Threshold value monitoring	•
Time stamp	•
Inputs / outputs	
Digital inputs	15
Digital outputs (as switch or pulse output)	3
Temperature measurement input	1
Password protection	•
Communication	
Interfaces	
RS485: 9.6 – 115.2 kbps	•
Ethernet 10/100 Base-TX (RJ-45 socket)	•
Protocols	
Modbus RTU, Modbus TCP	•
Modbus Gateway for Master-Slave configuration* ¹	•
NTP (time synchronisation)	•
DHCP	•
TCP/IP	•
ICMP (Ping)	•
Software GridVis®-Basic* ²	
Online and historic graphs	•
Databases (Janitza DB, Derby DB); MySQL, MS SQL with higher GridVis® versions)	•
Manual reports (energy)	•
Topology views	•
Manual reading	•
Graph sets	•

Technical data	
Digital inputs and outputs	
Number of digital inputs	15
Supply voltage	20 – 30 V DC (SELV or PELV supply)
Pulse output (S0), maximum count frequency	25 Hz
Input signal present	> 18 V DC (typical 4 mA for 24 V)
Input signal not present	0 ... 5 V DC
Number of digital outputs	3
Supply voltage	20 – 30 V DC (SELV or PELV supply)
Switching voltage	max. 60 V DC
Switching current	max. 50 mAeff DC
Pulse output (energy pulse)	max. 20 Hz
Maximum line length	up to 30 m unscreened, from 30 m screened
Temperature measurement input	1
Update time	1 sec.
Suitable temperature sensor	PT100, PT1000, KTY83, KTY84
Total burden (sensor and cable)	max. 4 kOhm

Mechanical properties and others	
Weight	200 g
Device dimensions in mm (H x W x D)	90 x 107,5 x approx. 46
Battery	Lithium battery CR2032, 3 V (approval i.a.w. UL 1642)
Protection class per EN 60529	IP20
Assembly per IEC EN 60999-1 / DIN EN 50022	DIN rail mounting
Connection capacity of the terminals (digital inputs / outputs, temperature thermistor inputs) rigid / flexible	0.2 to 1.5 mm ²
Flexible with core end sheath without plastic sleeve	0.2 to 1.5 mm ²
Flexible with core end sheath with plastic sleeve	0.2 to 1.5 mm ²
Terminal connection capacity	
Serial interface	
Single core, multi-core, fine-stranded terminal pins, core end sheath	0.2 to 1.5 mm ² 0.2 to 1.5 mm ²
Environmental conditions	
Temperature range	Operation: K55 (-40 ... +70 °C)
Relative humidity	Operation: 0 to 95 % RH
Operating altitude	0 ... 2,000 m above sea level
Pollution degree	2
Mounting position	any
Electromagnetic compatibility	
Electromagnetic compatibility of operating equipment	Directive 2004/108/EC
Electrical appliances for application within particular voltage limits	Directive 2006/95/EC
Equipment safety	
Safety requirements for electrical equipment for measurement, regulation, control and laboratory use – Part 1: General requirements	IEC/EN 61010-1
Particular requirements for Test and measurement current circuits	IEC/EN 61010-2-030
Noise immunity	
Class A: Industrial environment	IEC/EN 61326-1
Electrostatic discharge	IEC/EN 61000-4-2
Electromagnetic fields 80 – 1000 MHz	IEC/EN 61000-4-3, EMV-ILA V01-03
Electromagnetic fields 1000 – 2700 MHz	IEC/EN 61000-4-3, EMV-ILA V01-03
Rapid transients	IEC/EN 61000-4-4, EMV-ILA V01-03
Surge voltages	IEC/EN 61000-4-5, EMV-ILA V01-03
HF conducted interferences 0.15 – 80 MHz	IEC/EN 61000-4-6, EMV-ILA V01-03
Voltage dips, short term interruptions, voltage variations and frequency change	IEC/EN 61000-4-11, EMV-ILA V01-03
Emissions	
Class B: Residential environment	IEC/EN 61326-1
RFI Field Strength 30 – 1000 MHz	IEC/CISPR11/EN 55011
Radiated interference voltage 0.15 – 30 MHz	IEC/CISPR11/EN 55011
Radiated interference voltage 9 – 150 MHz	EMV-ILA V01-03
Safety	
Europe	CE labelling
USA and Canada	UL labelling
Firmware	
Firmware update	Update via GridVis® software. Firmware download (free of charge) from the website: http://www.janitza.com/downloads/

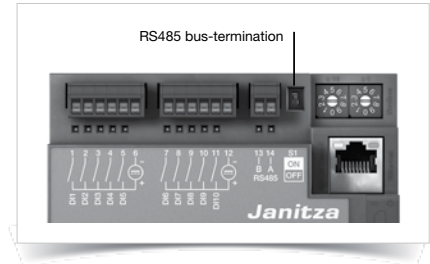

Fig.: Modbus / RS485 termination

Comment: For detailed technical information please refer to the operation manual and the Modbus address list.

• = included - = not included