



**Your Advantages**

- Preventive fire and system protection
- Detection of symmetric and asymmetric insulation faults
- Universal application in non-earthed AC, DC, AC/DC networks up to max. 300 V
- Suitable for large leakage capacitances up to 30  $\mu$ F
- Monitoring also with voltage-free mains

**Features**

- Insulation monitoring according to IEC/EN 61557-8
- Adjustable response threshold, Setting range: 1 k $\Omega$  ... 300 k $\Omega$
- 1 changeover contacts for insulation failure alarm
- Energized or de-energized on trip can be selected for indicator relay
- With multicolour status LED to indicate the state of operation
- Automatic and manual device self-test
- Manual reset or hysteresis function selectable (programmable via control input)
- Protection against manipulation by sealable transparent cover
- Control input for external test- / reset-button
- 2 wide voltage input for auxiliary voltage
- Width 35 mm

**Product Description**

The insulation monitor RL 5889 of the VARIMETER IMD family provides best and up to date insulation monitoring of modern IT systems in an optimum and state of the art way fulfilling the relevant standards. The device can be used in the most flexible way for AC, DC and AC/DC systems. The setting of the parameters and the switching values is done by simple and operator friendly rotational switches on front of the device. The operating status is indicated user friendly via a multicolour LED. With a sealable transparent cover the device is protectet against manipulation.

**Approvals and Markings**



**Function Diagram**

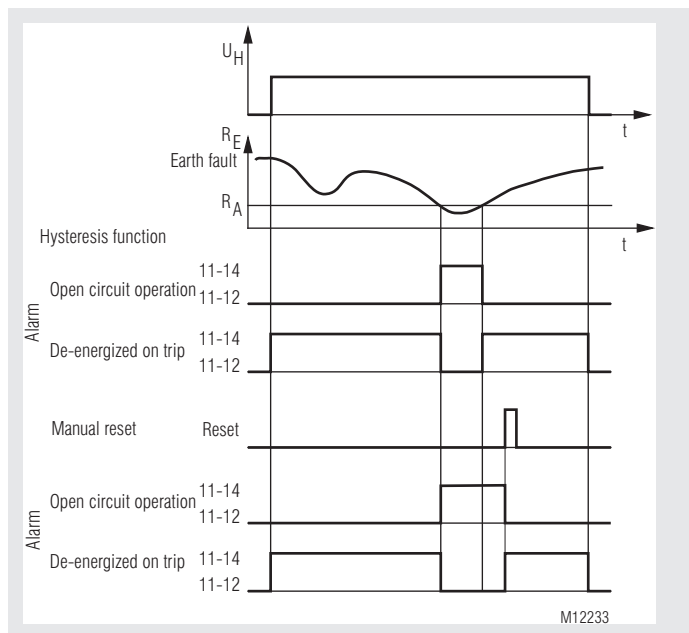

**Applications**

- Insulation monitoring of:
- Non-earthed AC, DC, AC/DC networks
  - UPS systems
  - Networks with frequency inverters
  - Battery networks
  - Networks with direct current drives
  - Hybrid and battery-powered vehicles

**Flashing Codes Status LED**

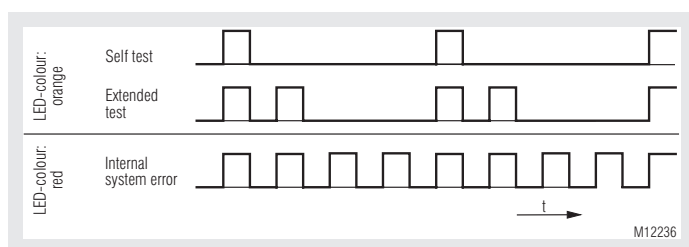

## Circuit Diagram

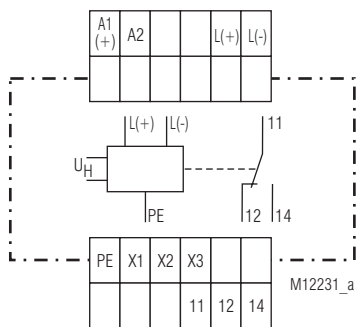

## Connection Terminals

Terminal designation	Signal description
A1(+), A2	Auxiliary voltage AC or DC
L(+), L(-)	Connection for Measuring circuit
PE1, PE2	Connection for protective conductor
X1, X2	Control input for external test-button
X2, X3	Control input for external reset-button or manual and auto reset: X2/X3 bridged: hysteresis function X2/X3 not bridged: manual reset
11, 12, 14	Alarm signal relay K1(1 changeover contact)

## Function

The device is supplied with DC auxiliary voltage via terminals A1(+) / A2. Switching on the auxiliary voltage (Power-On) is followed by an internal self-test for 12 s (see „Device test functions“). The test process is visible with the status LED. After this, measurement of the insulation resistance in the measuring circuits begins and the status LED changes into green.

### Measuring circuit

#### (Insulation measurement between terminals L(+) / L(-) and PE)

The terminals L(+) and L(-) are connected directly to the voltage system to be monitored.

The type of network (AC, DC, 3NAC) has to be selected via rotary switches „UN“.

The PE terminal is connected to the protective earth.

To measure the insulation resistance an active measuring voltage with changing polarity is connected between L(+)/L(-) and PE.

At the end of a measuring cycle the actual insulation resistance is produced and indicated. The relay for alarm K1 switch when dropping under the adjusted response values. In addition the LED changes to orange color on pre-alarm or to red color on alarm.

### Manual reset of fault message

The manual reset of insulation fault signals can be programmed via the control input X2/X3 (Manual reset: X2/X3 not bridged; No manual reset: X2/X3 bridged). If manual reset is activated the insulation fault signals of the measuring circuit are stored when dropping under the adjusted response values also if the insulation resistance goes back to healthy state. Pressing the „Test/Reset“ button on the front side for > 3 s, the alarm signal are reset if the actual insulation resistance is in healthy state.

### Indicator relay for insulation fault signal

For the indicator relay K1 (contacts 11-12-14) the function energized on trip (Rel. n.o.) or de-energized on trip (Rel. n.c.) can be set via rotational switch "UN" when the insulation resistance drops below the adjusted response value.

## Function

### Device test functions

Principally, 2 different test functions are implemented: The "self-test" and the "expanded test":

The self-test of the device is performed automatically after Power-On and every full operating hours. It can also be triggered manually at any time by pressing the "Test/Reset" button at the device front for < 3 sec.

With the self-test, contrary to the expanded test, the status of the Indicator relays is not affected; the sequence is as follows:

The self-test is indicated via LED with orange flash code 1. For approx. 5 s to negative test phase. Within these 5 s the internal measuring circuit is checked for failures. Then the measuring pulse is switched for approx. 5 s to positive test phase and more internal tests take place. If no failures turned up and had been recognized, the measurement continuous. The extended test procedure is started when during or at the end of the above described 12 s self-test the test button is pressed again for < 3 s.

The sequence is similar to the self-test (2 measuring phases of 5 s each) but in addition the output relays go in alarm stated. The LED shows orange flash code 2. The test phases of the extended test will be repeated continuously. Pressing the reset button again for > 3 s will stop the extended test immediately. The device starts the insulation measurement again.

### Behaviour with internal device faults

If internal device faults were detected during the test function, the LED flashes continuously red. The indicator relays K1 switch to the alarm state.

### External control input

To terminals X1/X2 an external combined Test-/Reset button can be connected. If the terminals X1/X2 are bridged for approx. 1 s the test mode is started. This has the same function as pressing the internal test button. When bridging X1/X2 for > 3 s, a stored alarm will be reset. This has the same function as pressing the internal reset button.

An external combined Test-/Reset button can be connected to terminals X2/X3. If the terminals X1/X2 are bridged for approx. 1 s a stored alarm will be reset (this has the same function as pressing the internal Test-Reset-button for > 3 s. If the terminals X2/X3 are bridged continuously the manual reset is inactive (hysteresis function).

### Programming/setting of parameters/set-up of the insulation monitor

All setting are done with 2 rotary switches on the front of the unit. To avoid unauthorized manipulation of the settings, all 3 switches are located behind a sealable transparent cover.

The first rotary switch "R<sub>A</sub>" sets the response value for alarm.

The second rotary switch "UN" selects the type of network connection. It is divided in 2 sections. If the setting position is in the first section, the relay output function is de-energized on trip, if the setting position is in the second section, the relay output function is energized on trip.

Via the control input X2/X3, manual reset or the hysteresis function can additionally be programmed by using a bridge between X2/X3 (Manual reset: X2/X3 not bridged; hysteresis function: X2/X3 bridged).

New settings are accepted without restart of the device.

## Indicators

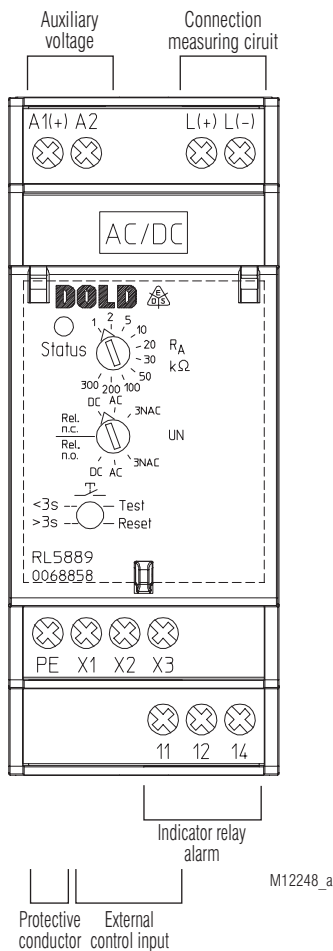

## Notes



### Risk of electrocution! Danger to life or risk of serious injuries.

- Disconnect the system and device from the power supply and ensure they remain disconnected during electrical installation.
- The terminals of the control input X1-X2-X3 have no galvanic separation to the measuring circuit L(+) and L(-) and are electrically connected together, therefore they have to be controlled by volt free contacts or bridge. These contacts ore bridges must provide a sufficient separation depending on the mains voltage on L(+)-L(-).
- Please do not connect external voltage to terminals X1/X2/X3. The control must only be made by bridging X1 and X2 or X2 and X3.



### Attention!

- Before checking insulation and voltage, disconnect the monitoring device RL 5889 from the power source!
- In one voltage system only one insulation monitor can be used. This has to be observed when interconnecting two separate systems.
- The device must not be operated without PE connection!



### Attention!

- The main measuring circuit can be connected with its terminals L(+) and L(-) both to the DC and also AC side of a mixed network; it is done most practically where the primary incoming power supply takes place e.g. battery networks with connected inverters on the DC side, with Generators/ Transformers with connected Rectifiers or inverters on the AC-side. To monitor a 3NAC system the device can be connected single pole, (L(+)) and L(-) are bridged, to the neutral of the 3p4w system. The 3 phases have a low-ohmic (approx. 3 - 5 Ohm) connection via the transformer windings so also insulation failures of the not directly connected phases are detected. Via the rotational switch „UN“ the correct type of network needs to be selected (see „Connection Examples“).
- If a monitored AC system includes galvanically connected DC circuits (e.g. via a rectifier), an insulation failure on the DC side can only be detected correctly, when a current of min 10 mA can flow via the semiconductor connections.
- If a monitored DC system includes galvanically connected AC circuits (e.g. via an inverter), an insulation failure on the AC side can only be detected correctly, when a current of min 10 mA can flow via the semiconductor connections.

## Indicators

The operational status of the device is indicated on a 3-colour LED:

- Off:** No auxiliary voltage connected  
**Green:** Normal operation (Insulation resistance in healthy state)  
**Red:** Alarm (measured value below alarm response value)  
**Orange flashing:** Test mode procedure (see flashing code diagramm)  
**Red flashing:** Failure code (see flashing code diagramm)

Flash code orange Status-LED	Description
1	Selftest (measuring circuit, measuring voltage, internal tests)
2	Advanced Test (additional control of indicator relays)

## Error Indication

Flash code red Status-LED	Failure cause	Failure recovery
Continuously flashing	Internal failure detected in test mode	Press test button again or restart the unit by interrupting the auxiliary supply temporarily. If the fault remains permanent, send device back to manufacturer for examination.

## Technical Data

### Measuring circuit L(+) / L(-) to PE1 / PE2

<b>Nominal voltage <math>U_N</math>:</b>	AC / DC 0 ... 240 V
<b>Max. voltage range <math>U_N</math>:</b>	AC / DC 0 ... 300 V
<b>Frequency range:</b>	DC or 40 ... 1000 Hz
<b>Max. line capacitance:</b>	30 $\mu$ F
<b>Internal resistance (AC / DC):</b>	> 120 k $\Omega$
<b>Measuring voltage:</b>	Approx. $\pm$ 12 V
<b>Max. measured current (RE = 0):</b>	< 0.1 mA
<b>Response inaccuracy:</b>	$\pm$ 15 % $\pm$ 1.5 k $\Omega$ IEC 61557-8
<b>Response value hysteresis:</b>	Approx. + 25 %; min. + 3 k $\Omega$

#### On delay

at $C_E = 1 \mu$ F,	
$R_E$ of $\infty$ to 0,5 * response value:	$\leq$ 5 s
at $C_E = 30 \mu$ F,	
$R_E$ of $\infty$ to 0,5 * response value:	$\leq$ 25 s

#### Response values:

Pre-warning („ $R_A$ “):

k $\Omega$ :	1	2	5	10	20	30	50	100	200	300
--------------	---	---	---	----	----	----	----	-----	-----	-----

Each adjustable via rotational switches

### Auxiliary voltage input A1(+)/A2

Nom. Voltage	Voltage range	Frequency range
AC/DC 24 ... 240 V	AC 19 ... 265 V	45 ... 400 Hz; DC 48 % W <sup>*)</sup>
	DC 16 ... 300 V	W <sup>*)</sup> $\leq$ 5 %
DC 12 ... 24 V	DC 10.8 ... 30 V	W <sup>*)</sup> $\leq$ 5 %

<sup>\*)</sup> W = Permitted residual ripple of auxiliary supply

#### Nominal consumption:

DC 12 V, 24 V, 48 V:	Max. 1.5 W
AC 230 V:	Max. 2.8 VA

### Control input X1/X2 for external combined Test-/Reset-button

<b>Current flow:</b>	Approx. 4 mA
<b>No-load operation voltage X1 to X2 or X2 to X3:</b>	Approx. 15 V
<b>Permissible wire length:</b>	< 50 m
<b>Activation time for test signal (X1/X2):</b>	Approx. 1 s
<b>Activation time for reset signal (X2/X3):</b>	Approx. 1 s

### Outputs

<b>Indicator contact:</b>	1 changeover contact for Alarm (K1) energized or de-energized on trip (programmable)
<b>Thermal current <math>I_{th}</math>:</b>	4 A
<b>Switching capacity to AC 15:</b>	
NO contact:	3 A / AC 230 V IEC/EN 60947-5-1
NC contact:	1 A / AC 230 V IEC/EN 60947-5-1
To DC 13:	1 A / DC 24 V IEC/EN 60947-5-1
<b>Electrical life at AC 15 at 1 A, AC 230 V:</b>	1,5 x 10 <sup>5</sup> switching cycles
<b>Short circuit strength max. fuse rating:</b>	4 A gG / gL IEC/EN 60947-5-1
<b>Mechanical life:</b>	$\geq$ 30 x 10 <sup>6</sup> switching cycles

## Technical Data

### General Data

<b>Operating mode:</b>	Continuous operation
<b>Temperature range:</b>	
Operation:	- 40 ... + 60 °C (device mounted without distance)
	- 40 ... + 70 °C (device mounted with 1 cm distance to adjacent devices)

Storage:	- 40 ... + 70 °C
<b>Altitude:</b>	$\leq$ 2000 m IEC 60664-1

#### Clearance and creepage distances

Rated insulation voltage:	300 V
Overvoltage category:	III
Rated impuls voltage / pollution degree:	IEC 60664-1
Measuring circuit L(+)/L(-) to auxiliary voltage A1(+)/A2 and indicator relay contacts K1:	6 kV / 2
Auxiliary voltage A1(+)/A2 to indicator relay contacts K:	6 kV / 2
Reinforced insulation between: (A1(+), A2) – (L(+), L(-), PE, X1, X2, X3) –	IEC 60664-1 IEC 62368-1 (11, 12, 14)

Insulation test voltage, Routine test:	AC 4 kV; 1 s
<b>EMC</b>	IEC/EN 61326-2-4
Electrostatic discharge:	6 kV (contact) IEC/EN 61000-4-2
	8 kV (air) IEC/EN 61000-4-2

HF-irradiation:	
80 MHz ... 6 GHz:	20 V / m IEC/EN 61000-4-3
Fast transients:	2 kV IEC/EN 61000-4-4

Surge voltages between wires for power supply:	1 kV IEC/EN 61000-4-5
Between wire and ground:	2 kV IEC/EN 61000-4-5
HF-wire guided:	20 V IEC/EN 61000-4-6
Interference suppression:	Limit value class B EN 55011

#### Degree of protection

Housing:	IP 30 (not sealed) IEC/EN 60529
	IP 40 (sealed with seal wire 50/30) IEC/EN 60529
The unit must be disconnected from the power supply before the seal is applied	

Terminals:	IP 20 IEC/EN 60529
<b>Housing:</b>	Thermoplastic with V0 behaviour according to UL subject 94

<b>Vibration resistance:</b>	Amplitude 0.35 mm frequency 10 ... 55 Hz, IEC/EN 60068-2-6
<b>Vibration resistance:</b>	Amplitude $\pm$ 1 mm, frequency 2 ... 13.2 Hz, 13.2 ... 100 Hz, acceleration $\pm$ 0.7 gn IEC/EN 60068-2-6

<b>Shock resistance:</b>	10 gn / 11 ms, 3 pulses IEC/EN 60068-2-27
<b>Climate resistance:</b>	40 / 070 / 04 IEC/EN 60068-1

<b>Terminal designation:</b>	EN 50005
<b>Wire connection</b>	DIN 46228-1/-2/-3/-4

Cross section:	0.5 ... 2.5 mm <sup>2</sup>
Stripping length:	7 mm
<b>Wire fixing:</b>	Cross-head screw / M3 box terminals
<b>Fixing torque:</b>	0.4 Nm
<b>Mounting:</b>	DIN rail IEC/EN 60715
<b>Weight:</b>	Approx. 105 g

### Dimensions

<b>Width x height x depth:</b>	35 x 90 x 71 mm
--------------------------------	-----------------

## Standard Types

RL 5889.11 AC/DC 24 ... 240 V

Article number: 0068858

- Auxiliary voltage: AC/DC 24 ... 240 V
- Outputs: 1 changeover contact for alarm
- Setting range alarm: 1 k $\Omega$  ... 300 k $\Omega$
- Max. line capacitance: 30  $\mu$ F
- Energized or de-energized on trip
- Selection of type of network
- Width: 35 mm

RL 5889.11 DC 12 ... 24 V

Article number: 0068859

- Auxiliary voltage: DC 12 ... 24 V
- Outputs: 1 changeover contact for alarm
- Setting range alarm: 1 k $\Omega$  ... 300 k $\Omega$
- Max. line capacitance: 30  $\mu$ F
- Energized or de-energized on trip
- Selection of type of network
- Width: 35 mm

## Connection Examples

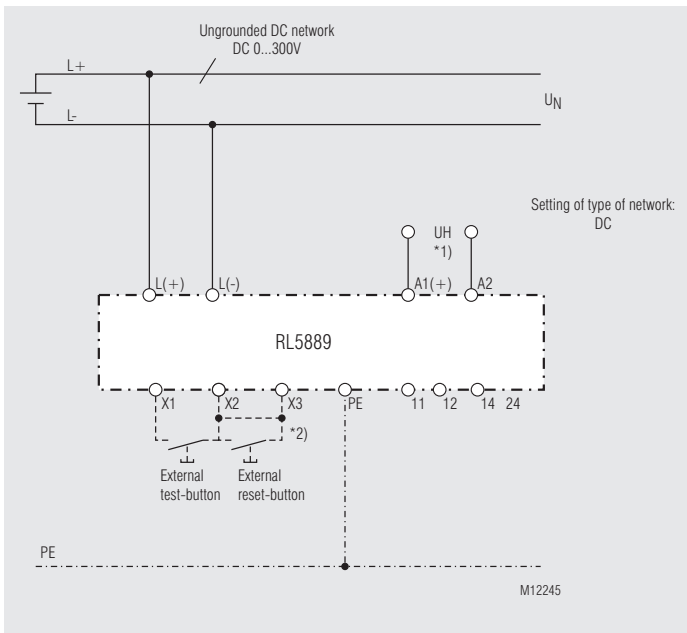
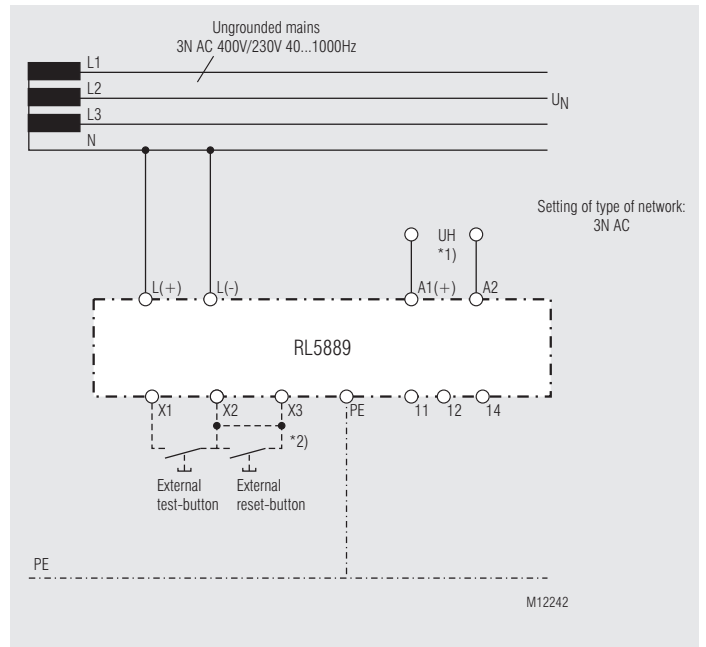
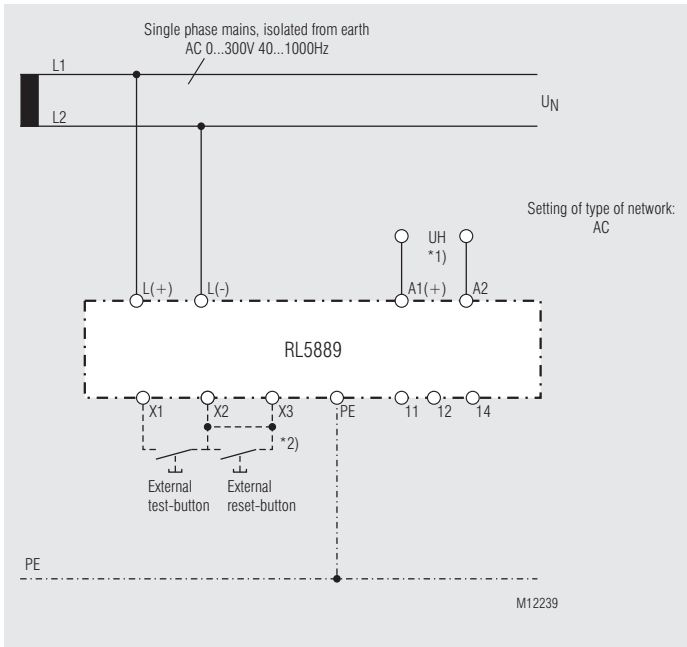

\*1) Auxiliary voltage  $U_H$  (A1(+)/A2) can also be sourced from the monitored voltage system.  
The voltage range of the auxiliary supply has to be taken into account.

\*2) Programming manual reset or hysteresis function:  
X2/X3 not bridged: Manual reset  
X2/X3 bridged: Hysteresis function

