

Part number

TAPH 06 L32



Surface mounting housing, T-TYPE /H series,
with 1 lever, M32 cable entry, size "44.27"

Product description

Product type	Surface mounting housing
Series	T-TYPE /H
Closing type	with 1 lever
Size	size "44.27"
Cable entry	M32

Technical data

IP degree of protection	IP66/IP69
--------------------------------	-----------

Further technical details

Weight	130,00 g
Operating temperature range (min, max)	-40°C ... +70°C

Material properties

Main material	Polypropylene (PP)
Other materials	Lever: polypropylene (PP) Gasket: HNBR
Colour	RAL 7012 grey, RAL 5005 blue

Approvals / Standards

Certifications	DNV-GL, BV
UL	ECBT2
cUL	ECBT8

General ordering information

EAN13 code	8015747209885
-------------------	---------------

Packaging Information

Packaging length	330,00 mm
Packaging height	210,00 mm
Packaging width	180,00 mm
Packaging weight	3,07 kg
Packaging volume	12,47 dm ³
Packaging description	Carton box
Packaging quantity	20 Pcs
Packaging EAN code	8015747210034
Sub-packaging weight	0,77 kg
Sub-packaging description	Plastic packaging
Sub-packaging quantity	5 Pcs
Sub-packaging EAN barcode	8015747210041

Part number

TAPH 06 L32



Catalogue drawings

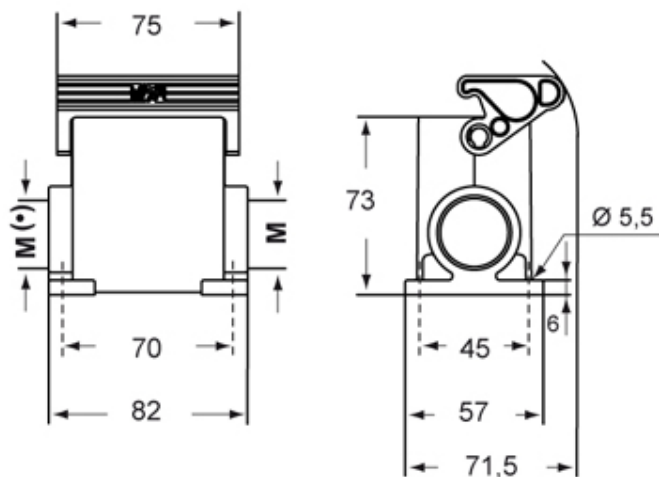

Notes

Dimensions shown in mm are not binding and may be changed without notice.