

Date: 2014.5.27

Area Designer UXM-30LAH-EWA configuration tool Instruction manual

Symbol	Amended Reason			Date	Amended by	DWG.NO
Approved by	Checked by	Drawn by	Designed by	Title	Area Designer Instruction Manual	
<i>Aoki</i>	<i>Aoki</i>	<i>Fukuda</i>	<i>Kristou</i>	Drawing No.	C-41-02495	1/51



[Introduction]

Make sure to read this manual before and during operation for the correct operation.

[About Area Designer]

By using this application, it is possible to monitor the sensor and area configuration. Also, it is possible to save measurement data and area data.

[Before use]

Make sure to read the specification of the sensor before operation.

[Precautions]

- Make sure to perform operations with a stable power supply listed in the product specifications and the user's manual. Operating under unstable power supply may damage the device.
- The actual product may differ from the illustrations and figures in this document as they are used for explanatory purposes only.
- All information in this user's manual is subject to change without prior notice.
- If you have any inquiry about the product, contact the nearest distributor or sales representative.

Title	Area Designer Instruction Manual	Drawing NO	C-41-02495	2 / 51
-------	-------------------------------------	---------------	------------	--------

Table of contents

1. System requirements	4
2. Installing the application.....	5
3. Using the application.....	8
4. Main window screen	9
4.1 Welcome to Area Designer screen.....	9
4.2 Main screen	11
4.2.1 Edit	11
4.2.2 Monitor.....	30
4.3 Data table.....	31
4.4 Sensor setting	33
4.5 IO simulation	35
4.6 Sensor information.....	38
4.7 Log data	39
4.8 Playing log data	40
4.9 About the application	41
5. Function of main window screen	42
5.1. Menu bar.....	42
5.1.1 File.....	42
5.1.2 Edit	43
5.1.3 View.....	44
5.1.4 Connections	45
5.1.5 Language	46
5.1.6 Help	46
5.2. Toolbar	47
5.2.1 Basic tool.....	47
5.2.2 Connection tool	48
5.2.3 Mode selection tool	48
5.2.4 Measurement display tool	48
5.3. Main view toolbar	49
5.4. Status bar	49
Appendix A Network address.....	51
Appendix B Troubleshooting.....	51

Title	Area Designer Instruction Manual	Drawing NO	C-41-02495	3 / 51
-------	-------------------------------------	---------------	------------	--------

1. System Requirement

The minimum system requirement for the operation of Area Designer is as follows.
After reading the operation manual of computer, check the operating environment.

Computer	CPU	Pentium® III processor of 800MHz or above
	RAM	256MB or above
	Hard disk	100MB minimum free space
Compatible OS	Microsoft® Windows XP Professional 32bit (SP3 or above)	
	Microsoft® Windows 7 Professional	
	Microsoft® Windows 8	
Display	High color (16bit color) or above, 800×600 dot or above	

The operation in the below system environment cannot be guaranteed.

- Other OS that is not mentioned above
- NEC PC98 series and its compatible device
- Self made PC
- Multi boot environment
- Multi monitor environment
- Upgraded OS from the standard installed OS

Caution

- Operation is not guaranteed even if the minimum system requirements are fulfilled.

Title	Area Designer Instruction Manual	Drawing NO	C-41-02495	4 / 51
-------	-------------------------------------	---------------	------------	--------

2. Installing the application

In this section it will explain how to install application in Windows. Refer to Appendix A for network address set up.

1. This application can be downloaded from our company's website. In order to install this application, double click the installer "Area Designer".
2. Double click the installer "Area Designer" and the following screen will be displayed. Here the language can be changed at the time of installation.

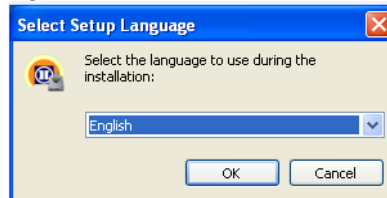

Fig 2-1 Select the language for an installer

3. As shown in Fig 2.1 click "ok" then it displays the screen of the installation location of Area Designer. If there is no particular specification then, click "next".

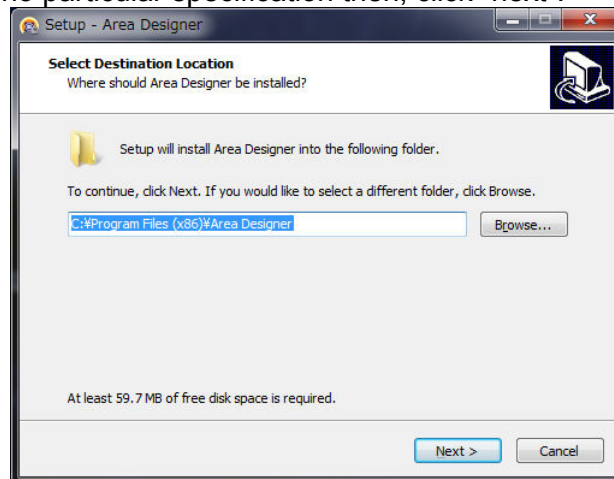

Fig 2-2 Specify the location for an installation

Title	Area Designer Instruction Manual	Drawing NO	C-41-02495	5 / 51
-------	-------------------------------------	---------------	------------	--------

4. As shown in Fig 2.2 click “next”, then select the component of “Area Designer”.
If there is no particular specification then click “next”.

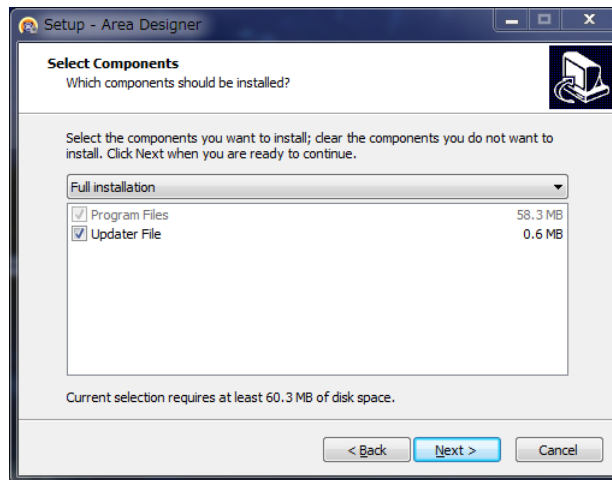

Fig 2-3 Select the component

5. As shown in Fig 2-3, click “next” then user will be proceed to specify the program group of “Area Designer”. If there is no particular specification then click “next”.

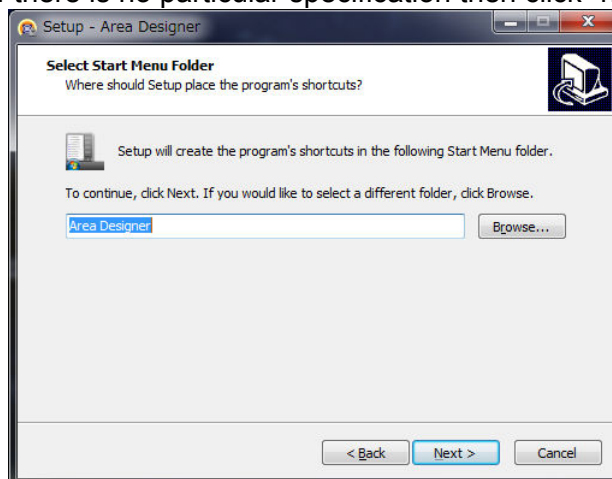

Fig 2-4 Specify the program group

Title	Area Designer Instruction Manual	Drawing NO	C-41-02495	6 / 51
-------	-------------------------------------	---------------	------------	--------

6. Once you click next as shown in Fig 2-4 then, proceed to additional task select screen. After selecting the additional tasks you would like for this setup to perform while installing, then click next.

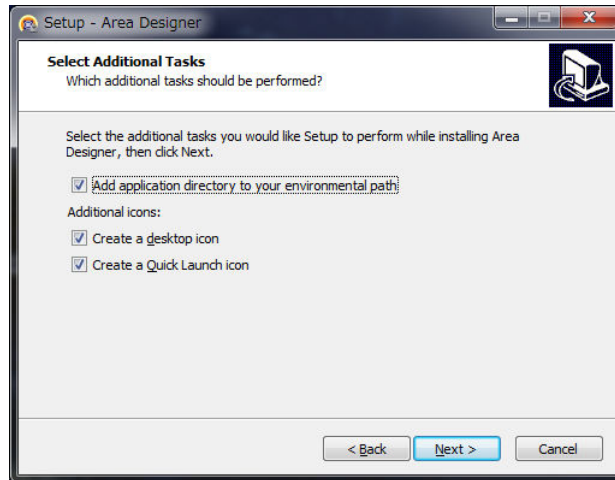

Fig 2-5 Select additional tasks

7. As shown in Fig 2-5, click next then, installation of “Area Designer” will start.

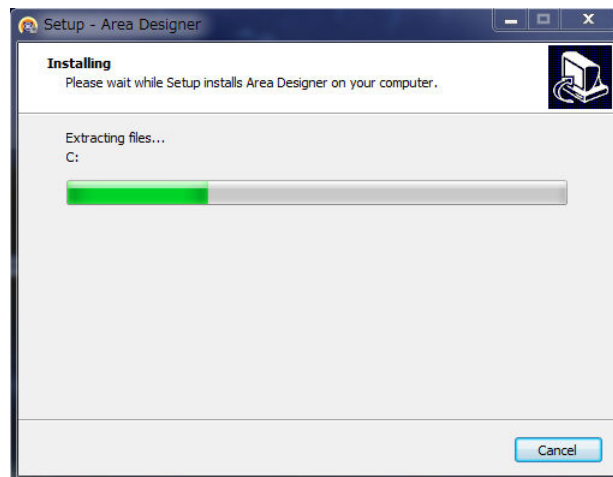



Fig 2-6 Installation in progress

Title	Area Designer Instruction Manual	Drawing NO	C-41-02495	7 / 51
-------	-------------------------------------	---------------	------------	--------

3. Using the application

1. Power supply to the sensor. Connect Ethernet cable with computer.
2. Click  Start menu → All programs → Area Designer. Or Double click Area Designer shortcut icon as shown on the desktop below Fig 3.1.

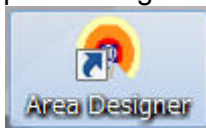

Fig 3.1 Area Designer icon

3. Starts the Area Designer application.

Title	Area Designer Instruction Manual	Drawing NO	C-41-02495	8 / 51
-------	-------------------------------------	---------------	------------	--------

4. Main window screen

When the application is started, this will explain the main window screen displayed.

4.1 Welcome to “Area Designer” screen

If application starts, the following window will be displayed as shown in Fig. 4.1-1. Table 4.1-1 explains details of three buttons of this window.

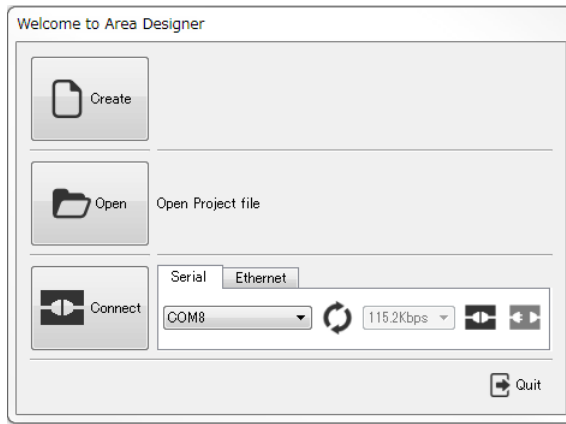





Fig 4.1-1 Welcome to “Area Designer” screen

Table 4.1-1 Button of “Welcome to Area Designer” screen

Button	Description
	Create a new project file.
	Open an existing project file.
	Connect with the sensor.

In table 4.1-3 Details of the components will be explained as below.



Fig 4.1-2 Serial connection component

Table 4.1-3 Serial connection component

Icon	Name	Description
	Serial COM Port	The connected COM port number will be displayed. When using multiple sensors, select the COM port which you want to connect.
	Rescan	Rescan of serial port will be performed and the number of connected COM port will be displayed again.
	Select Baud rate value	Select the baud rate value of RS422 when connected.
	Connect	Connects with COM port and starts communication.
	Disconnect	Disconnect the communication.

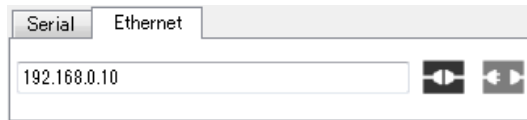





Fig 4.1-3 Ethernet connection component

Table 4.1-4 Ethernet connection component

Icon	Name	Description
	Input IP address	Input IP address which you want to connect. The port number is fixed.
	Connect	Connects with the IP address and starts communication.
	Disconnect	Disconnect the communication.

4.2 Main screen

This is the main window used for area configuration and monitoring. Edit screen and monitor screen can be switched by view →mode [/edit] and [/monitor] of the menu bar. Click the  or  icon from the toolbar for switching the mode. The main screen window of edit mode and monitor mode will be different.

4.2.1 Edit

In this screen, write area configurations to the sensor. Beside that, user can read the area configurations from the sensor and display the area configuration from sensor.

Edit/Monitor Switch

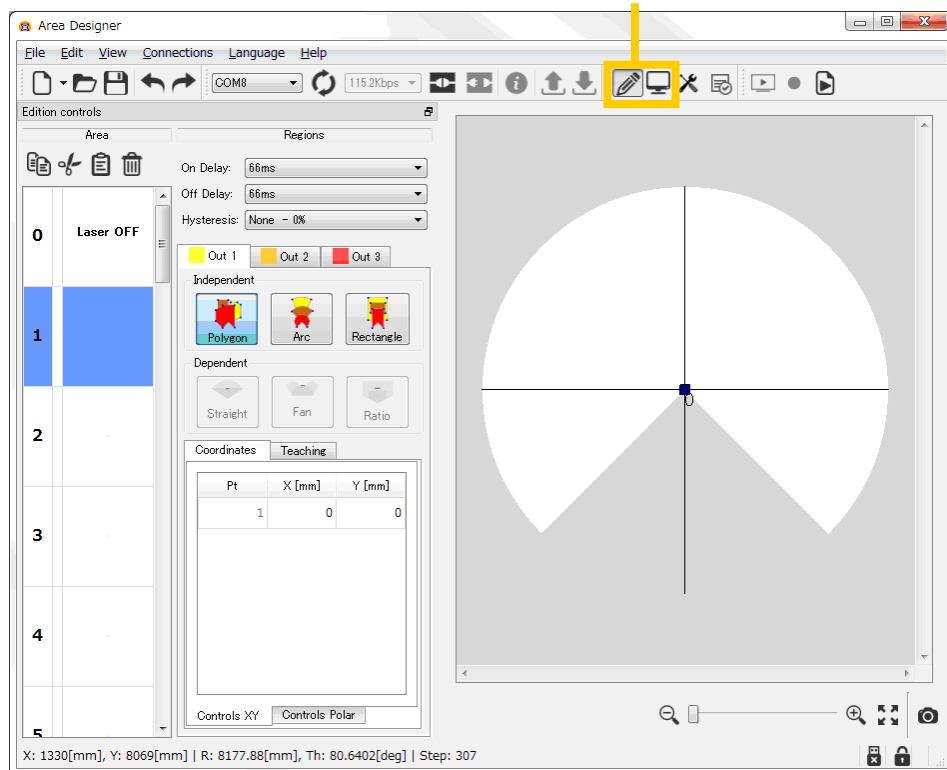



Fig 4.2.1-1 Default status in edit mode

Title	Area Designer Instruction Manual	Drawing NO	C-41-02495	11 / 51
-------	-------------------------------------	---------------	------------	---------

As shown in Fig 4.2.1-2   icons of no.1 are used for undo or redo operations of the icon no.2 through 6. As shown in the Fig. 4.2.1-2 icon no.2 through 4 are used for area configurations and operations. "Areas" refers to the regions configured with a maximum of 3 outputs displayed on the main view of no. 6 as shown in Fig 4.2.1-2.

The regions displayed in yellow, orange and red on the main view represent each individual output region. As shown in Fig.4.2.1-2 No.5 and No.6 are used for the area configurations and operations of each output region.

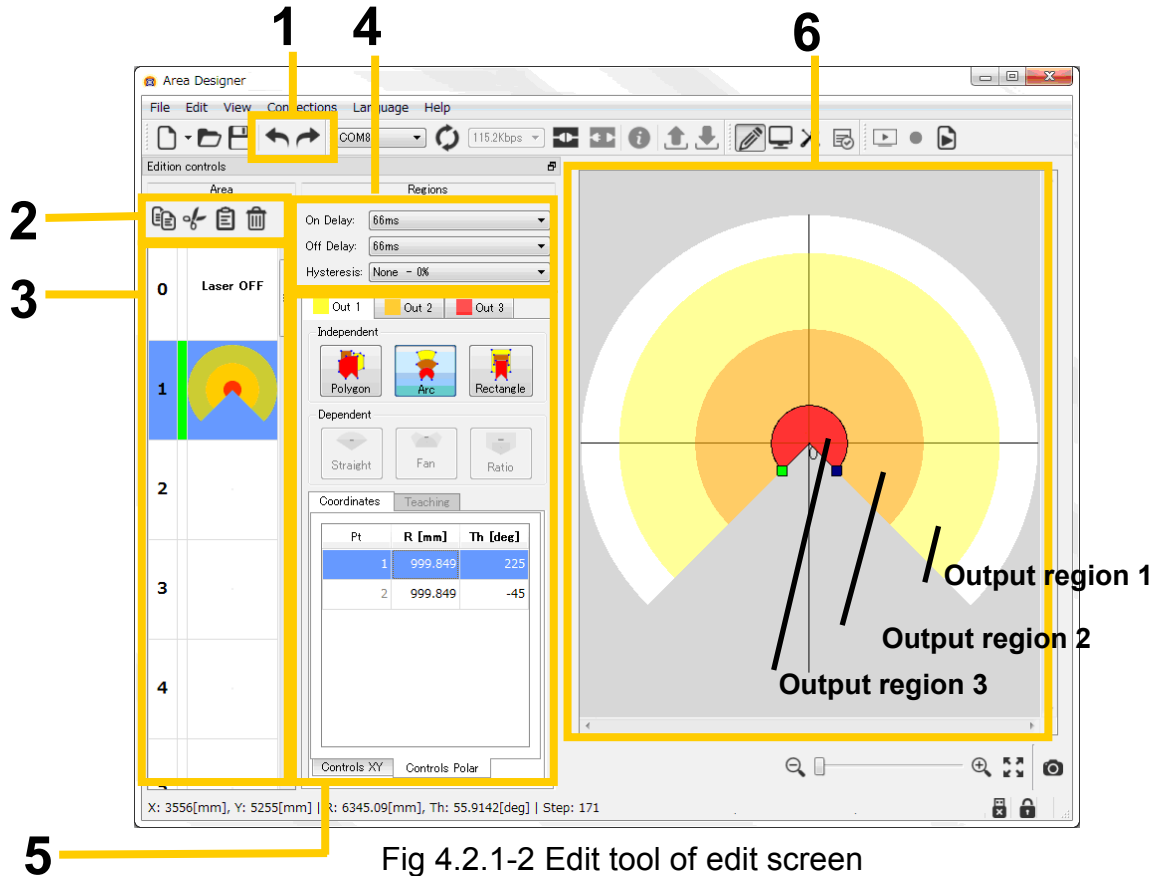

Fig 4.2.1-2 Edit tool of edit screen

Title	Area Designer Instruction Manual	Drawing NO	C-41-02495	12 / 51
-------	-------------------------------------	---------------	------------	---------

4.2.1.1 Area

In this the setting and operation of the present configured area is shown.

Copy, paste or read and write of the selected area can be performed.

4.2.1.1.1 Copy, Cut, Paste, Delete

As shown in Fig 4.2.1.1.1 [Copy] , [Cut] , [Paste] , [Delete] .

When you want to paste data of under configuration area to another area, [Copy] and [Cut] are used. [Copy] on the left the data of selected area and paste in another area. [Cut] deletes the data of selected area and pastes it in another area. [Delete] eliminates the data of the selected area.



Fig 4.2.1.1.1 Copy, Cut, Paste, Delete

Caution

- Copy, Cut, Paste and Delete tools cannot be used for each output region. Also, these tools can be only used for each individual area; they cannot be used for multiple areas.

4.2.1.1.2 Area preview

In Fig.4.2.1-2 the functions of number 2 and 3 are used for the area preview. When the background of the area number selected in the area preview turns blue, that area can be edited. The area that can be edited will be displayed on the main view illustrated in Fig.4.2.1-2. The top left number in the area preview is the area number. When changing area configuration, the editing mode of the selected area in the area preview will turn to green and area is changed will be displayed in a tool tip.

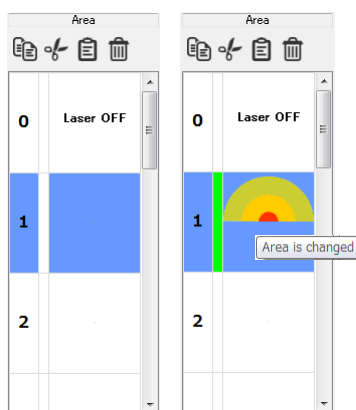

Fig 4.2.1.1.2-1 Left: Area preview of default status,
Right: Area preview of edit status

By right clicking in the area preview, the background of the selected area will change to blue and display the sub menu as illustrated in Fig. 4.2.1.1.2-2. Functions listed in this sub menu can be used for the area selected.

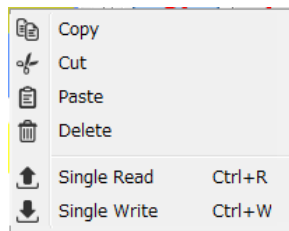

Fig 4.2.1.1.2-2 Menu displayed by the right click of Area preview

Cautions

- Area configuration is not possible in area 0, as laser is OFF.
- The menu function can be used only for selected area. It is not possible for multiple areas.

4.2.1.1.3 ON/ OFF delay

As shown in Fig 4.2.1.1.3 ON/OFF delay can be configured for each area. The configurable range of ON/OFF delay setting is 50 to 6400(ms) and width is 50(ms).

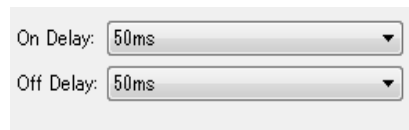

Fig 4.2.1.1.3 ON / OFF delay setting

Title	Area Designer Instruction Manual	Drawing NO	C-41-02495	14 / 51
-------	-------------------------------------	---------------	------------	---------

4.2.1.2 Regions

As shown in Fig 4.2.1.2, Output 1 to 3 is displayed when selecting the tabs, or click on any of outputs as displayed in yellow, orange, and red on the main view. Then it is possible to edit the selected outputs.

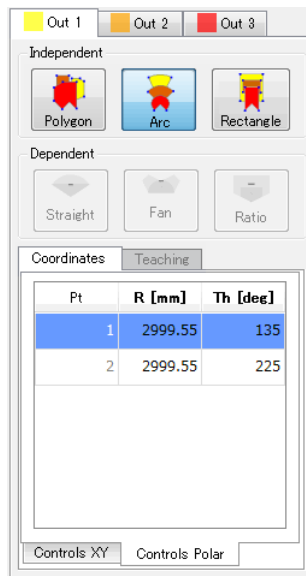

Fig 4.2.1.2 Tab of output regions 1 to 3

Quick/Useful tips

- When deleting the point of an area, select the point which you want to delete then right click the mouse. The Backspace or delete key can be used for deleting the point.
- In the case when you want to make an adjustment to point position, hold the Ctrl Key and move the mouse so the point moves in 10 (mm) intervals. And, if you hold the Shift Key and move the mouse the point then moves in 100(mm) intervals. Also, if you hold the Ctrl Key and Shift Key move the mouse the point then moves in 1000(mm) intervals.

4.2.1.2.1 Independent

In this section, it explains how to configure the output of an independent shape. There are the 3 types: polygon, arc and rectangle. When one of these independent shapes is selected, the point will be added to the center point of the main view (refer to Fig. 4.2.1.2.1). By moving this point, a region of the selected shape can be configured.

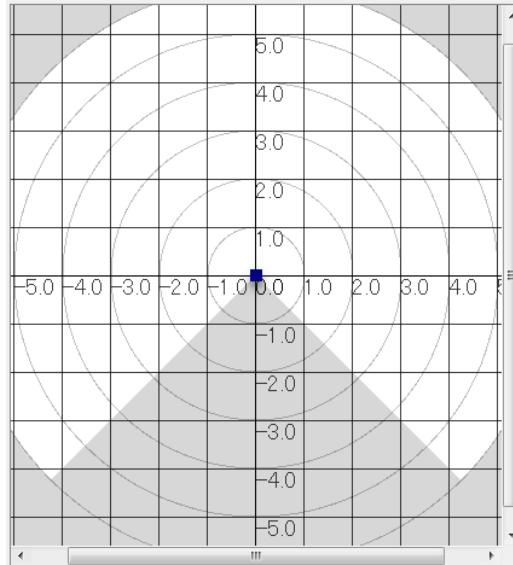

Fig 4.2.1.2.1 Default state during independent shape selection

When configuring an independent shape, there is a region where outputs can be configured as well as a region where outputs cannot be configured. The regions where an output can be configured are referred to as configurable region. The regions where outputs cannot be configured are referred to as an un-configurable region. As shown in Fig.4.2.1.2.1 the configurable area region is in **white** while the un-configurable area region is in **gray**.

Title	Area Designer Instruction Manual	Drawing NO	C-41-02495	16 / 51
-------	-------------------------------------	---------------	------------	---------

4.2.1.2.1.1 Polygon

Polygons can be used as a configured area if the intended shape of the output cannot configure as arc or rectangle. The information shown with a polygon configuration will display the numbers of points configured and X and Y coordinates of each point in the main view window. As shown in Fig.4.2.1.2.1.1 here is an example of polygon configuration.

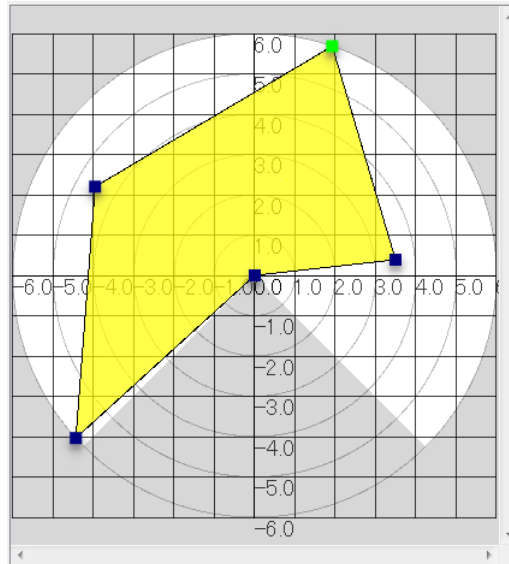

Fig 4.2.1.2.1.1-1 Example of polygon configuration

When a point is deleted, the output will be configured to form a straight line between one point to another depending on the one removed. If one is the center point, then the output will be configured such that one point it forms a straight line with the center point. When all the points are deleted other than the center point, the entire output region will be deleted.

Title	Area Designer Instruction Manual	Drawing NO	C-41-02495	17 / 51
-------	-------------------------------------	---------------	------------	---------

Caution

- Maximum 30 points can be configured with a polygon.
- When an area is configured with more than 31 points, first write the area into the sensor and then read the area from the sensor, as shown in Fig. 4.2.1.2.1.1-3; the points will be displayed in all steps within the configured area. Although it is possible to write an area with more than 31 points to configure into the sensor, the writing of point information on the area cannot be guaranteed. In the event an area with more than 31 points, the maximum number of points that can be displayed in the main view is the maximum number of steps of the sensor + 1 point.

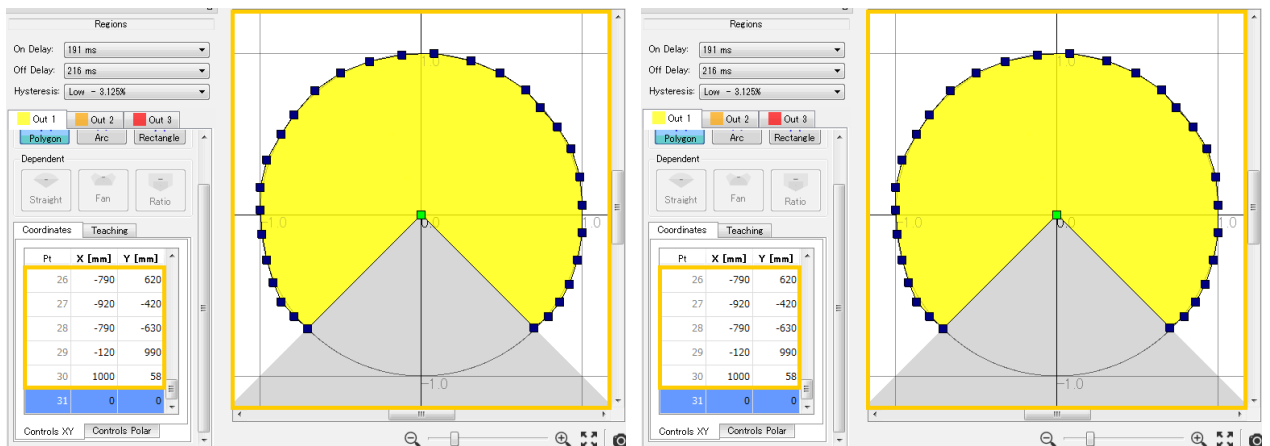

Fig 4.2.1.2.1.1-2 Left: Example of 30 points or less within the area

Right: Display an area of 30 points or less when read from the sensor

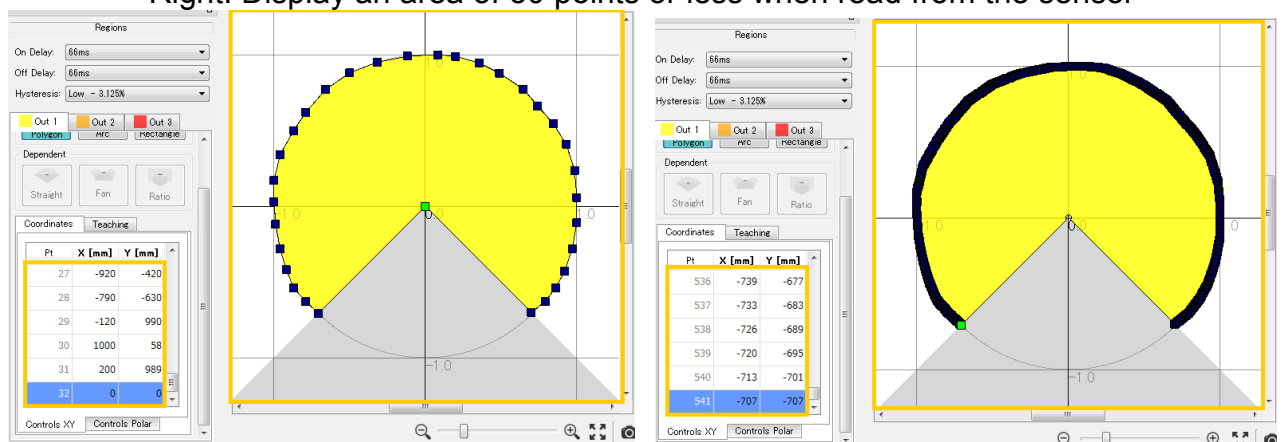

Fig 4.2.1.2.1.1-3 Left: Example of more than 31 points within the area

Right: Display an area of more than 31 points when read from the sensor

4.2.1.2.1.2 Arc

When configuring arc, the point information is shown below.
Fig. 4.2.1.2-6 consists of 2 output points.

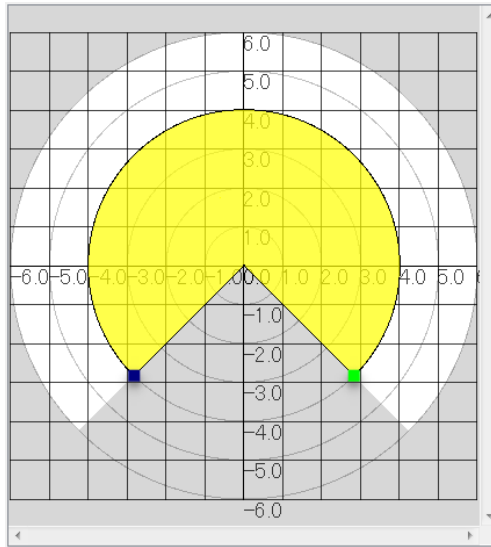

Fig 4.2.1.2.1.2 Example of Arc configuration

The point information of an arc shape consists of the 2 angles to each point from the starting angle of 0° on the main view and saves the information of the radius of arc. The output area of an arc shape is configured from these 2 angles and the radius of the arc. When the radius of one point is changed, the radius of other point is also changed of same value. If either of one point is deleted, the other point and the output region will be also deleted.

Title	Area Designer Instruction Manual	Drawing NO	C-41-02495	19 / 51
-------	-------------------------------------	---------------	------------	---------

4.2.1.2.1.3 Rectangle

The output of a rectangle is configured of 4 points as illustrated in Fig. 4.2.1.2.1.3.

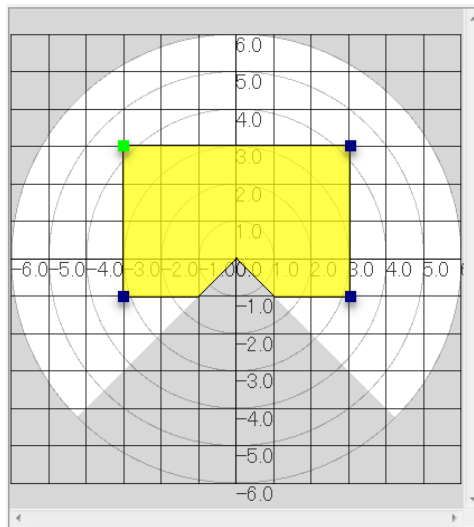

Fig 4.2.1.2.1.3-1 Example of rectangle configuration

The point information of a rectangle consists of last selected point and the opposite 2 points of selected points. Based on the relative values between these 2 points, the horizontal and vertical lengths of the rectangle are calculated. The output of a rectangle is then configured and that does not include the unavailable region.

When any one of the 4 points is moved, the coordinates of other opposite points will be changed. Points will change as drawing the rectangle's 4 points and it doesn't include the unavailable region. When any one point of the rectangle is deleted, the other points and the output region will also be deleted.

It is only possible to move a point to the unavailable region while configuring a rectangle (refer to Fig. 4.2.1.2.1.3-2 for moving point in the unavailable region). The configured output is a region enclosed within the 4 points and that does not include the unavailable region.

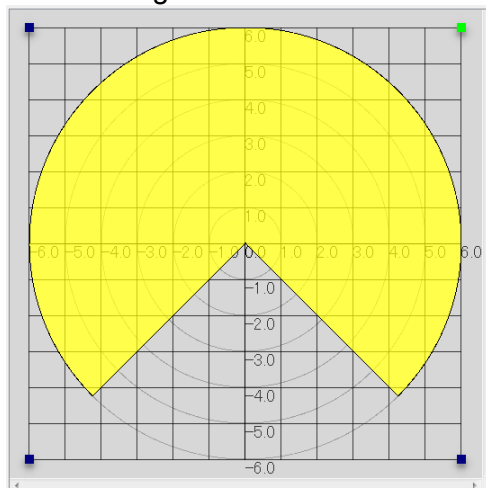

Fig 4.2.1.2.1.3-2 when configuration of rectangle points moves to unavailable region

Title	Area Designer Instruction Manual	Drawing NO	C-41-02495	20 / 51
-------	-------------------------------------	---------------	------------	---------

4.2.1.2.2 Dependent

This section will explain how dependent-shaped outputs of the region are changed within the range of outer most (upper) output. The outer most output refers to Output 1 (yellow) within this area is Output 2 (orange) and lastly Output 3 (red) referenced to Output 2. Since Output 1 is the outer most output, when it is changed, the regions of Output 2 and Output 3 are changed automatically. Straight line, Fan shape, and Ratio are the types of dependent shapes. As shown in Fig. 4.2.1.2.2 blue offset bar can be used for different area configuration. When the offset bar is selected, it will be displayed in a lime green (yellow- green) color.

The configurable range of the offset bar is within the range of 0 – 100%. When selecting a dependent shape, Default offset bar will be displayed as in Fig. 4.2.1.2.2. The value of offset bar can be set through left-clicking the mouse.

Cautions

- Output 1 as the outermost range, it is not possible to configure as a dependent shape.

Quick/Useful tips

- It is possible to delete the offset value of the point by right clicking of the mouse when the offset bar is selected, or press delete or the backspace key on the keyboard. The offset bar as shown in Fig.4.2.1.2.2 will be displayed in the default position of the coordinate origin.

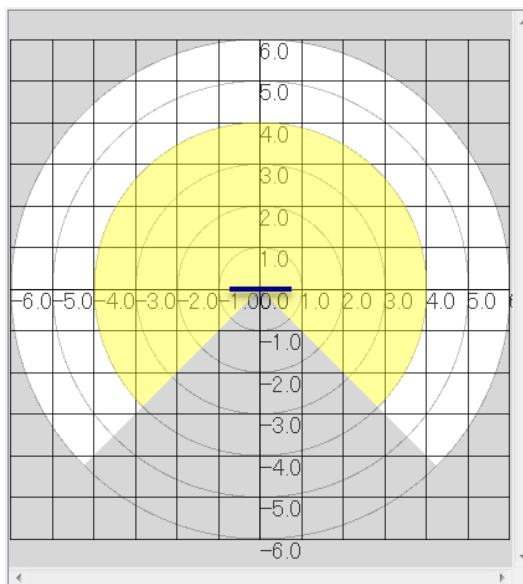

Fig 4.2.1.2.2 Default position of dependent offset bar

Title	Area Designer Instruction Manual	Drawing NO	C-41-02495	21 / 51
-------	-------------------------------------	---------------	------------	---------

4.2.1.2.2.1 Straight Line

Within outer most output, the maximum distance of Y axis from the position of the coordinate origin of the main view is considered as 100%. The coordinate origin is at the 0% position. Based on the configured position of the offset bar, calculate the y-direction linear distance of the straight line to configure output of a straight line that is dependent of the outer most output.

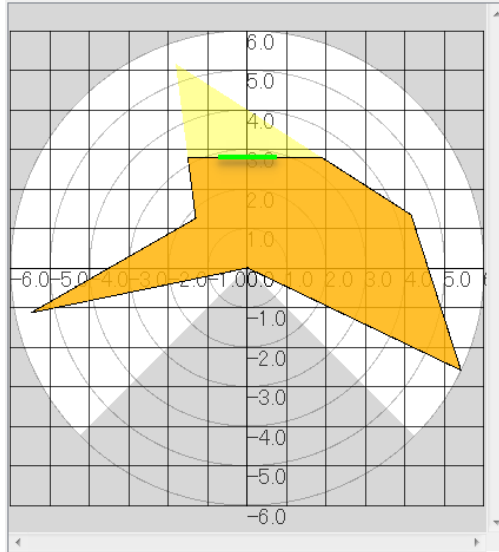

Fig 4.2.1.2.2.1 Example of straight line

4.2.1.2.2.2 Fan shape

In the outer most output area, the farthest distance of a point from the center point is considered as 100% and coordinate origin is considered as 0%. Based on the configured position of the offset bar, calculate the radius of the arc of the fan shape to configure fan-shaped output so that is dependent of the outer most output area.

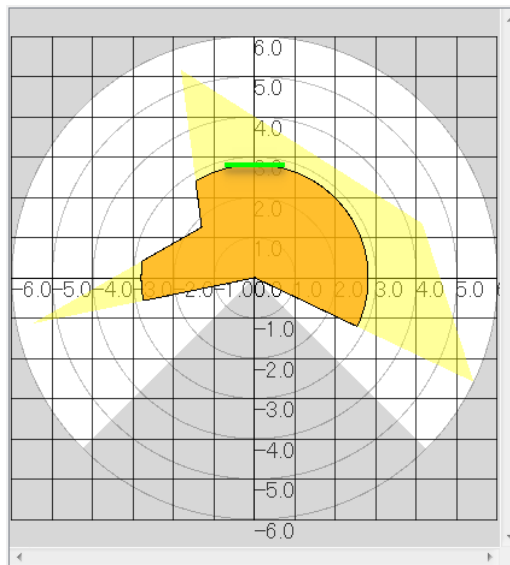

Fig 4.2.1.2.2.2 Example of fan shape

Title	Area Designer Instruction Manual	Drawing NO	C-41-02495	22 / 51
-------	-------------------------------------	---------------	------------	---------

4.2.1.2.2.3 Ratio

In the outer most output, the farthest distance of a point from the center point is considered as 100% and coordinate origin is considered as 0%. Calculate the ratio shape to configure ratio-shaped output so that is dependent of the outer most output area.

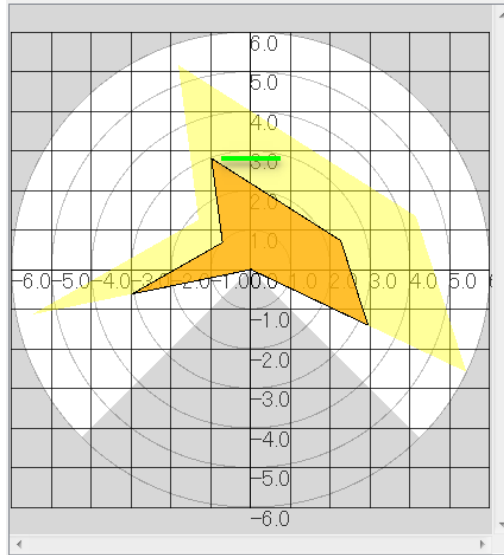

Fig 4.2.1.2.2.3 Example of ratio

Caution

- Offset bar may be displayed on the upper position rather than the output on the coordinates Y-axis. In case the outer most output is rectangle or polygon of an independent shape, the maximum distance of this output is not necessarily in the positive direction of the Y-axis coordinate. One of the points of outer most output will be the maximum distance.

Title	Area Designer Instruction Manual	Drawing NO	C-41-02495	23 / 51
-------	-------------------------------------	---------------	------------	---------

4.2.1.2.3 Numerical input

In this section it will explain how to configure the area by numerical input of XY coordinates and polar coordinates for independent shapes and dependent shapes separately.

When configuring the area, ID position information is assigned to each point coordinate. Point ID is displayed in the Pt column of numerical input. After selecting a point when the mouse is placed on the main view, the tool tip of the selected point ID will be displayed as illustrated in Fig. 4.2.1.2.3. Displayed tool tip is the point ID number.

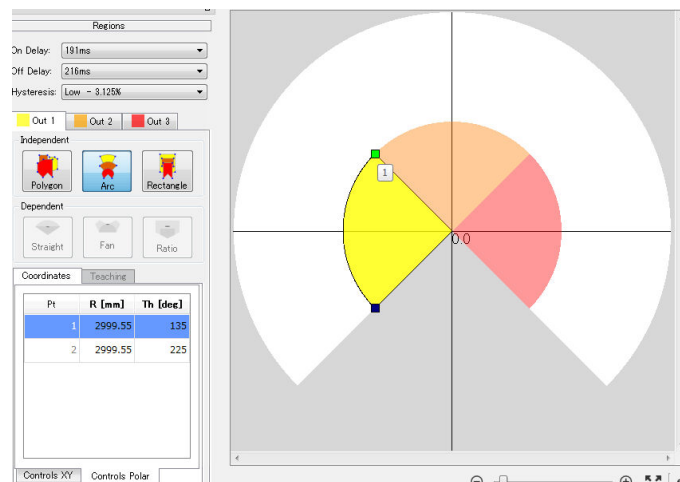

Fig 4.2.1.2.3 Point ID assigned to each point

The point ID is assigned in order to identify the coordinate position information of each point (here the coordinate position information of point will be referred to as point information). The point ID starts from 1 up to maximum 541.

The coordinates X, Y and the radius of arc for numerical input is displayed in [mm] units and the angle is displayed in [deg] units.

In order to correct the positions of the points coordinates, double click on the area which you want to change. Input the changed value, move to other cell or press the enter key. When the change is completed, the changed output will be displayed on the main view.

Caution

- Maximum of 30 points is guaranteed while writing a polygon shape into the sensor. Although 31 or more points can be written into the sensor of polygon shape, it cannot guarantee the point's information.

Quick/Useful tips

- While the numerical input row is selected with a blue display, the delete or backspace key can be pressed and the point information of that row will be deleted.

4.2.1.2.3.1 Numerical input of Independent

Fig. 4.2.1.2.3.1-1 illustrates the default state of numerical input screen when selecting the rectangle independent shape. Output on the main view is displayed as illustrated in Fig. 4.2.1.2.1.

As In Fig. 4.2.1.2.3.1-1, rectangle is configured of 4 points therefore four rows will be displayed. With using a polygon, the default state of numerical input value is configured of one point and one row will be displayed. If using an arc shape, it is configured of 2 points, and then two rows will be displayed.

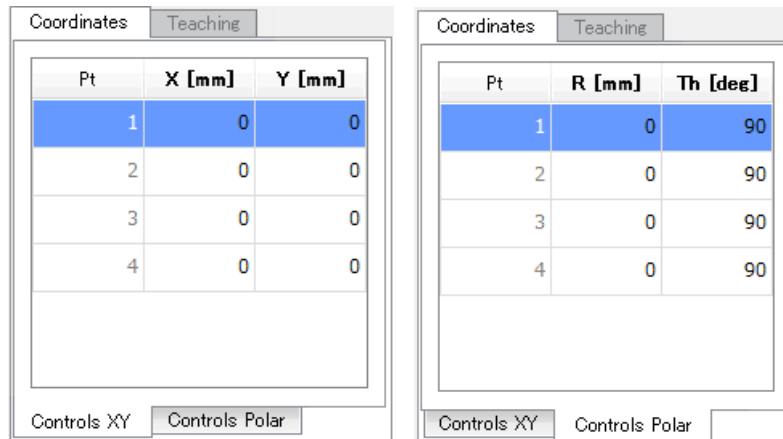

Fig 4.2.1.2.3.1-1 Example of default state of Numerical input screen during independent rectangle selection
(Left: XY Coordinates, Right: Polar Coordinates)

With using a polygon shape, when a point is deleted, the ID of that corresponding point is deleted and ID assigned after the deleted point ID is decreased by one. If a rectangle or arc has been selected, ID will be assigned in order of smaller step.

By changing the values of the XY coordinates or the value of the polar coordinates of each point ID in numerical input screen, the output will be displayed in the main view. In Fig. 4.2.1.2.3.1-2 shows an example of arc configuration by numerical input.

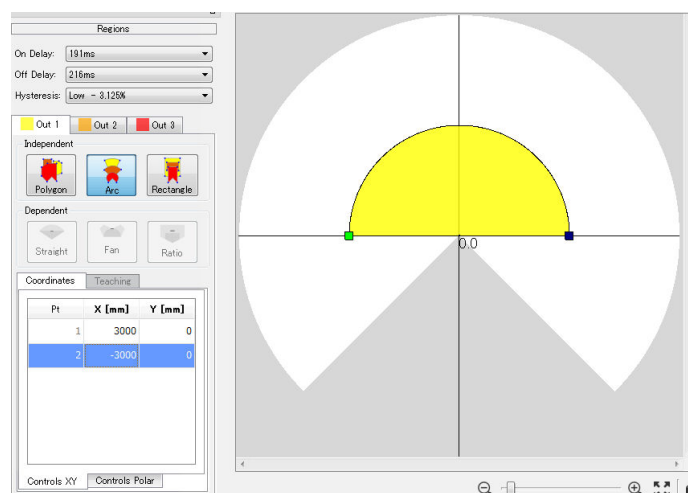

Fig 4.2.1.2.3.1-2 Example of arc configuration by numerical input

4.2.1.2.3.2 Numerical input of dependent

When a dependent shape is selected, a single row of point information ID will be displayed in numerical input screen. Default state of numerical input is illustrated in Fig. 4.2.1.2.3.2-1. As illustrated in Fig. 4.2.1.2.2, it shows the default state of numerical input when fan shape, straight line or ratio of dependent is selected.

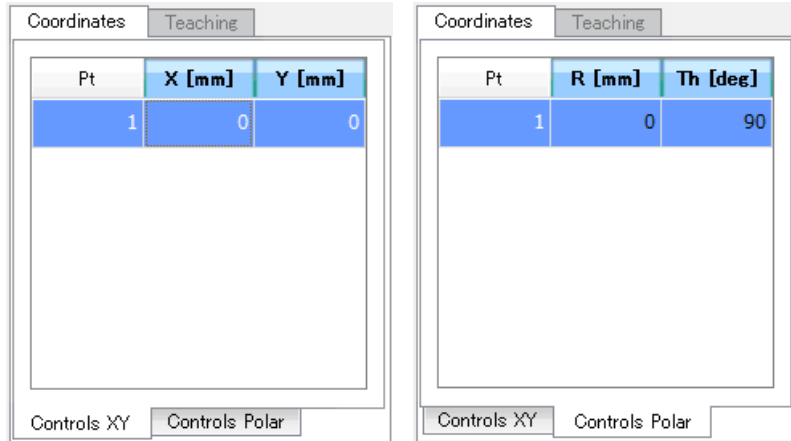

Fig 4.2.1.2.3.2-1 Default state of numerical input screen during selection of a dependent shape
(Left: XY coordinates, Right: polar coordinates)

In the numerical input of XY coordinates, it is possible to change the value of y coordinate only and in the numerical input of polar coordinates, it is possible to change the value of radius only. In Fig. 4.2.1.2.3.2-2, it shows an example of fan shape by numerical input.

When selecting the point ID in numerical input screen, if Backspace or Delete key is pressed, the screen will return to the default state as illustrated in Fig. 4.2.1.2.2.

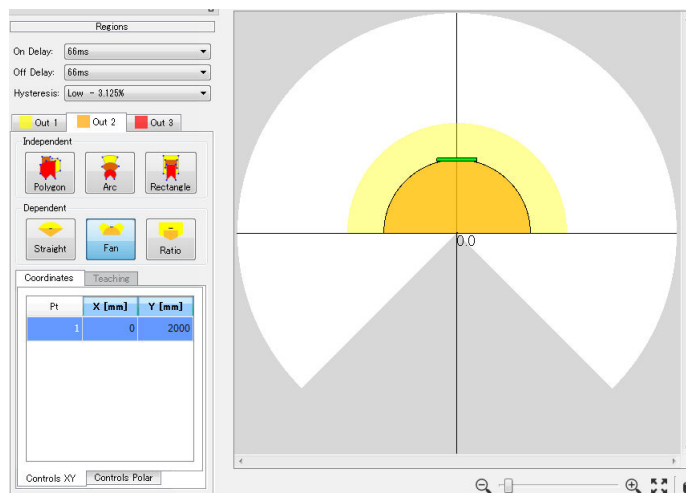

Fig 4.2.1.2.3.2-2 Example of fan shape by numerical input

4.2.1.2.4 Teaching

Only when polygon as an independent shape is selected, then “Teaching” tab next to “Coordinates” tab will be active. When teaching tab is clicked the configurations screen as illustrated in Fig. 4.2.1.2.4-1 will be displayed. It will be possible to set the teaching function. This teaching function enables an area to be configured based on a background obtained by scanning the sensor.

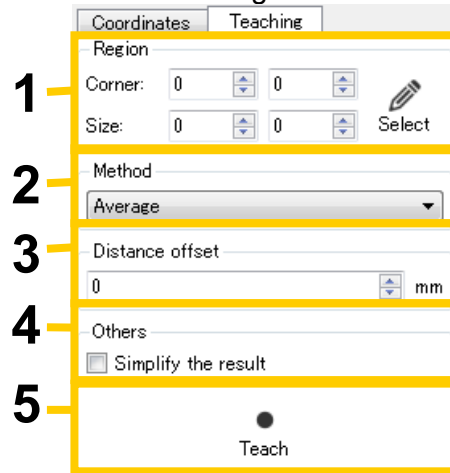

Fig 4.2.1.2.4-1 setting of teaching

Operating method is configured in the order as illustrated in Fig. 4.2.1.2.4-1.

1. Specify the region to perform teaching. Click [Select] in the default state, and the pink dot will be displayed in the center of the main view. Specify the region with this round dot. Also, it is possible to specify the region by selecting the values for “top left” (numerical input on the left is the X coordinate value and numerical input on the right is the Y coordinate value) and “size” (the numerical input on the left is the width from the top left and numerical input on the right is the height from the top left).

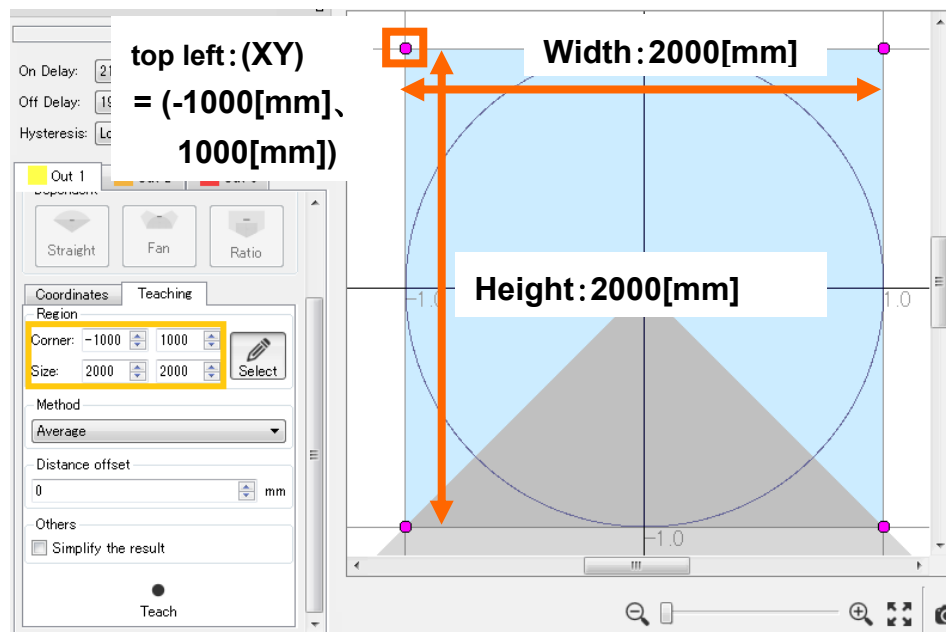

Fig 4.2.1.2.4-2 Specify the region for teaching

- Set the method of teaching. "Average Value" calculates the average values of the distance scanned during teaching and selects this value as the background. "Minimum Value" selects the minimum value scanned during the teaching and selects this value as the background.
- Specify distance offset. During teaching with distance offset of 100 [mm], configure an image similar as illustrated in Fig. 4.2.1.2.4-3. The pink waveform is the configured region and the green waveform indicates the distance. The difference between the pink and green waveform is the difference of offset value.

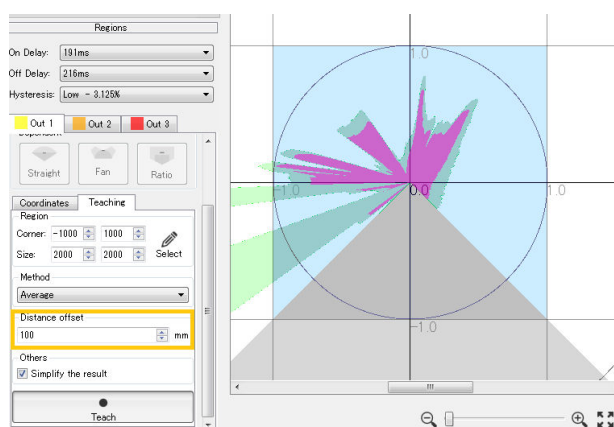

Fig 4.2.1.2.4-3 Display the region configured by teaching (pink) and Distance region (green)

- In the event of minimizing point displayed during teaching, place a check in "Simplify the result". When there is no check, it will display the point of each step of the region in which the background exists.

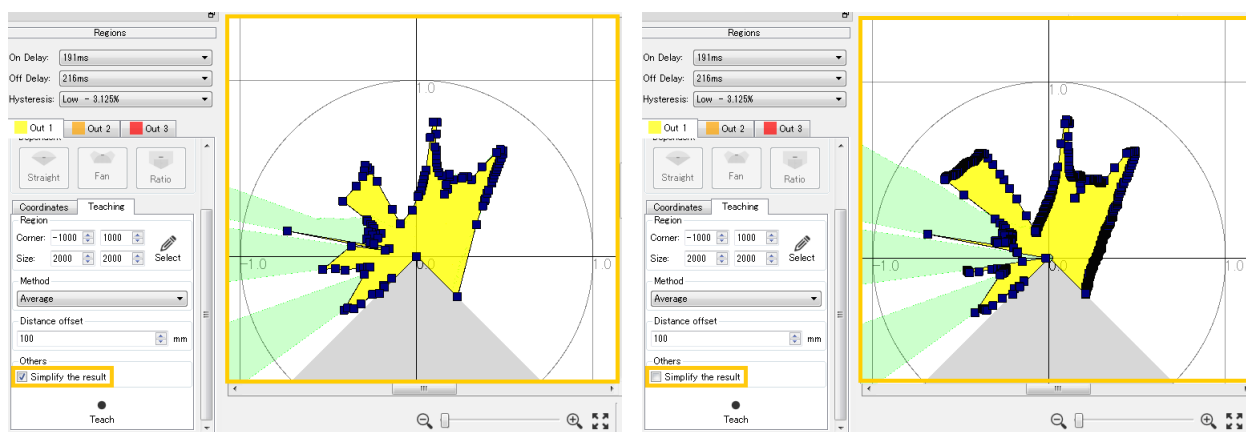

Fig 4.2.1.2.4-4 Left: When a check placed in "Simplify the result"
Right: When not check in "Simplify the result"

- Teaching will start when "● Teach" is clicked. In order to set teaching region to the sensor, it is necessary to write the configuration to the sensor.

4.2.1.2.5 Origin offset from the center of scanning beam

As shown in the left of Fig. 4.2.1.2.5, normally output is formed with point of origin included. If the red point near the point of origin point is moved, as shown in the right of Fig. 4.2.1.2.5, output without the point of origin as origin offset from the center of scanning beam can be configured. Therefore, output without point of origin is known as origin offset from the center of scanning beam.

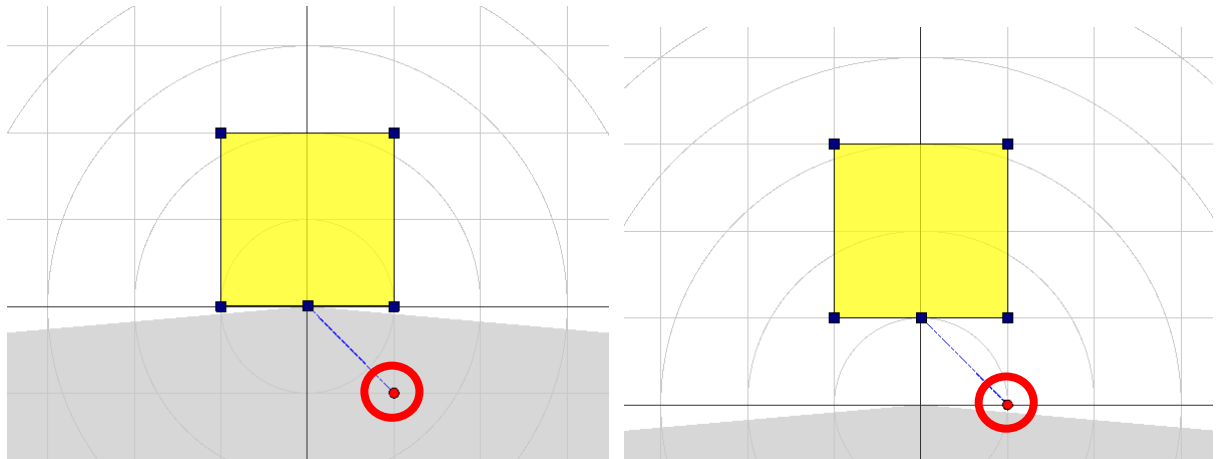

Fig. 4.2.1.2.5 Left: Output including point of origin Right: Origin offset from the center of scanning beam

Quick/Useful tips

- When returning the center point of departed area to its point of origin, select the red point then right click the mouse. The Backspace or delete key can also be used for returning to its point of origin.
- In the event when you want to make an adjustment to center point of departed area, hold the Alt key and you can make the adjustment. In the case when you want to make a slight adjustment to center point of departed area, hold Ctrl Key and Alt key and move the mouse and then the point moves in 10 (mm) intervals. If you hold the Alt key and Shift Key and move the mouse then the point moves in 100(mm) intervals. Also, by holding the Alt key, Ctrl key and Shift Key and moving the mouse, then the point moves in 1000(mm) intervals.

Cautions

- In dependent shape and teaching mode, origin offset from the center of scanning beam is not movable.

Title	Area Designer Instruction Manual	Drawing NO	C-41-02495	29 / 51
-------	-------------------------------------	---------------	------------	---------

4.2.2 Monitor

In this screen, data measurement, record and play of log data, IO information check and monitoring of a sensor are performed.

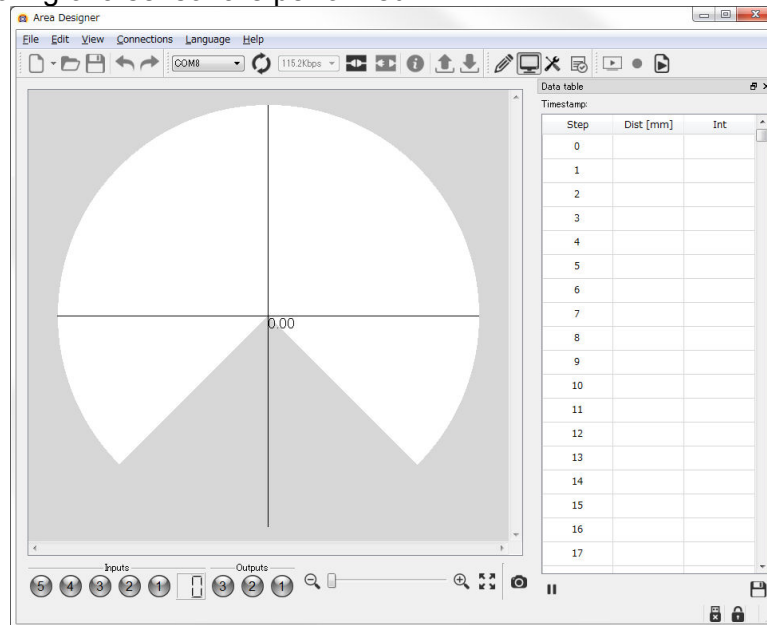

Fig 4.2.2-1 Monitor screen

IO information that is displayed in the monitoring screen is configured as illustrated in Fig. 4.2.2-2. The input values are binary numbers (0 indicates gray while 1 indicates green) and the area numbers are displayed as decimal values. Status display of the output lamp is explained in Table 4.2.2

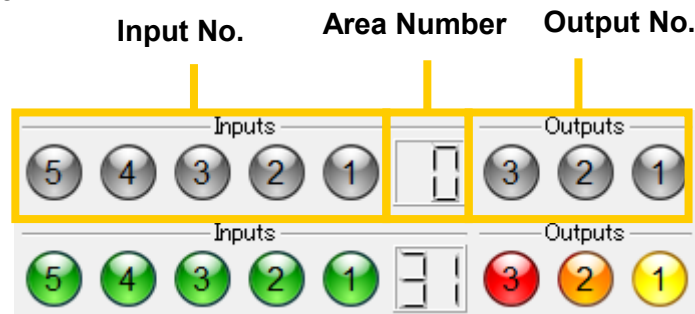

Fig 4.2.2-2 IO lamp display in monitor screen

(Top: Display when disconnected from the sensor, Bottom: Display when connected to the sensor)

Table 4.2.2 Status display of IO lamp

Lamp	Description
	Displays when disconnected from the sensor or IO in the OFF state. Numbers on the each lamp are IO values.
	Display when the input is in ON state. Numbers on the each lamp are IO values.
	Output 1 lamp ON during object detection.
	Output 2 lamp ON during object detection.
	Output 3 lamp ON during object detection.

Title	Area Designer Instruction Manual	Drawing NO	C-41-02495	30 / 51
-------	-------------------------------------	---------------	------------	---------

4.3 Data table

Click [View] → [Data Table] of the menu, the window illustrated as in Fig. 4.3-1 will be displayed. Also, it is possible to display this same table by shortcut keys of “Ctrl + T”. This window is used for displaying the measured distance, confirms the information of the output data and saves the displayed numerical values into a CSV file. When the display of the measured data is started, a time stamp [units: us (micro seconds)] is displayed in the top of the data table. Also the distance and intensity is displayed in the data table.

This explains the details of the display tools in Table 4.3-1

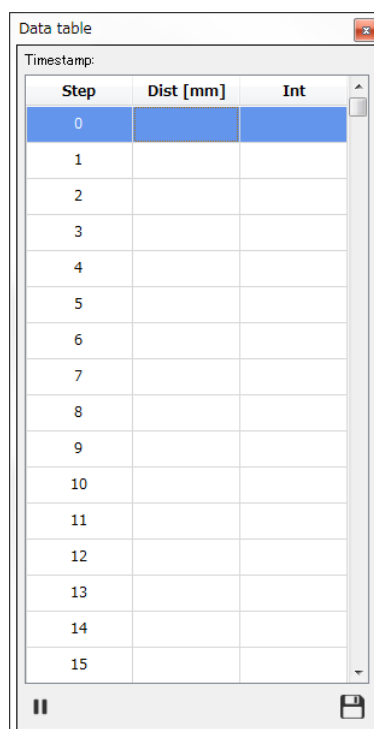





Fig 4.3-1 Data table

Table 4.3-1 Data table

Icon	Name	Description
	Pause	Stops the update of the numerical value information.
	Start update	Starts the update of the numerical value information.
	Save	1 scan of the displayed measured data is saved as CSV file.

When the row of data table is clicked, it is inverted and displayed in blue. At this time, a blue line will be displayed at the step position corresponding to the clicked row. A blue line will be displayed as illustrated in Fig. 4.3-2.

Also, when the main view is clicked; a blue line will be displayed on that area. During this, the row of the corresponding step on the data table will be inverted and displayed in blue.

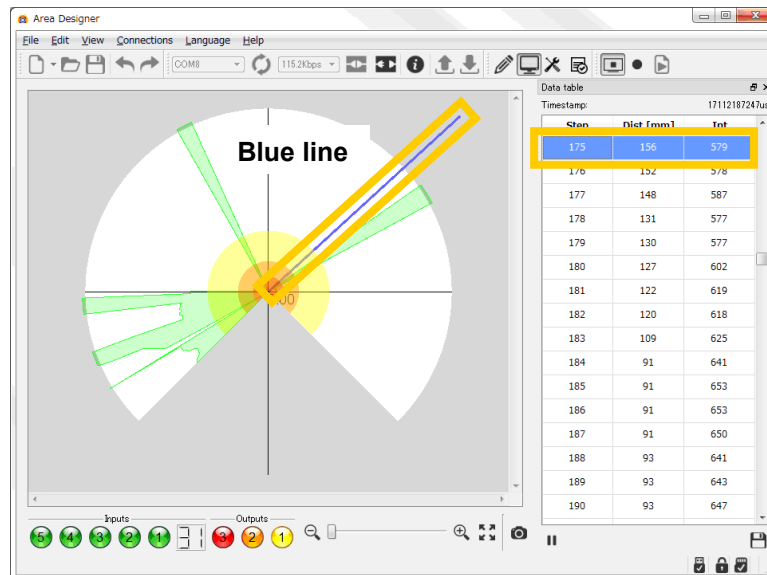



Fig 4.3-2 Display with blue line in the monitor screen

4.4 Sensor settings

This window is used to set parameters of the sensor. Click [View] in the menu bar → [Mode] → [ / Sensor settings] or the  icon in the tool bar, and the window illustrated in Fig. 4.4 will be displayed. By using shortcut keys of “Ctrl + Alt + S” also the below window can be displayed. The details of the tools displayed will be explained in Table 4.4-1. In table 4.4-1 [Read] and [Write] can only be used when there is connection with the sensor.

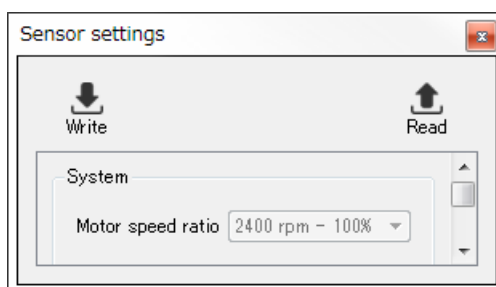



Fig 4.4 Sensor setting

Table 4.4-1 Display of sensor setting

Icon	Name	Description
	Read	Read the parameter from sensor.
	Write	Write the configured parameter into sensor.

In the case of changing the internal parameter of the sensor, from the sensor setting the user needs to change the value of parameter then click write to sensor. When you want to read the internal parameter of the sensor then click read from sensor.

Cautions

- When the parameters have changed, the background display will be yellow and inverted because of the parameter in the sensor settings is different from the internal settings of the sensor. By clicking read or write if the sensor settings and internal setting of the sensor are same it will then return to its original color.

In table 4.4-2 it explains the details of configurable parameters by sensor setting. In order to reflect the configured items into the sensor, it is necessary to write to the sensor. Be sure to refer to the product specifications and the user's manual for information regarding the configurations.



Title	Area Designer Instruction Manual	Drawing NO	C-41-02495	33 / 51
-------	-------------------------------------	---------------	------------	---------

Table 4.4-2 Parameter setting

Parameter		Description
Motor sync angle		To prevent mutual interference motor synchronize angle can be set.
Heater		To prevent dew condensation at the time of low temperature.
Output logic		Inverting outputs logic can be set.
Filters	Rain	Used to remove rain and snow
	Fog	Used to remove fog.
	Sensitivity	Used to remove low reflection object.
	Echo	To judge the first echo or the last echo.
Hysteresis	Upper limit	Hysteresis upper limit can be set in the range of 0~250[mm]
	Lower limit	Hysteresis lower limit can be set in the range of 0~250[mm]
Minimum detectable size		Width of minimum detectable size can be set in the range of 10 ~1000[mm].
Limited detection capacity zone		Limited detection capacity zone can be set in the range of 60mm ~ 3000[mm].

Title	Area Designer Instruction Manual	Drawing NO	C-41-02495	34 / 51
-------	-------------------------------------	---------------	------------	---------

4.5 IO Simulation

This simulation is used to test the IO information of the sensor. While the sensor is connected, change to the monitoring screen, in the menu bar View → Mode → [IO Simulation] and the  icon in the toolbar will be active. Click the icon or the shortcut keys of “Ctrl + Alt + I” and the window illustrated in Fig. 4.5-1 will be displayed. The  / Apply icon is used to apply the configurations of the simulation to the sensor and start the test.

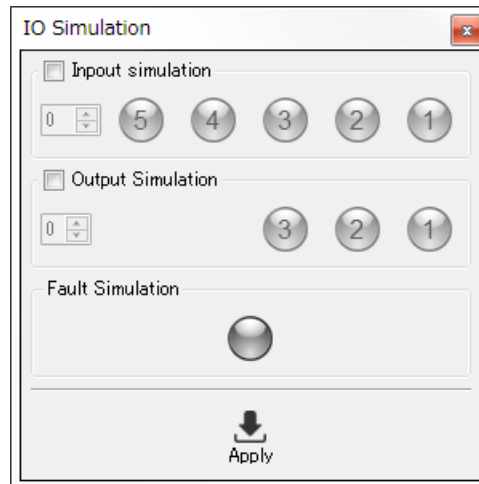

Fig 4.5-1 IO Simulation

[In case of input/output simulation test]

1. This shows when a check mark is placed in the input simulation checkbox or the output simulation for which to perform the test. When a check mark is placed, as illustrated in Fig. 4.5-2, the Numerical input checkbox and the buttons will be active.

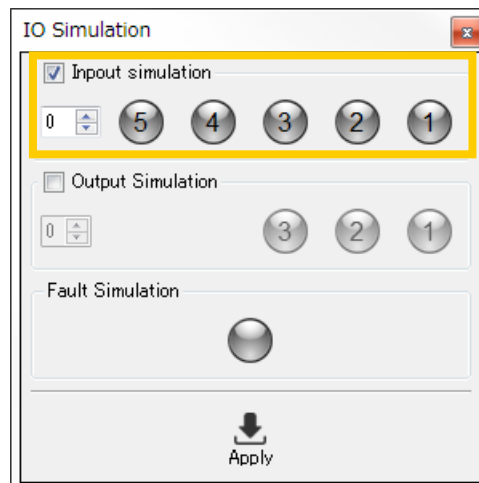

Fig 4.5-2 Display when the check box of input simulation is active

Title	Area Designer Instruction Manual	Drawing NO	C-41-02495	35 / 51
-------	-------------------------------------	---------------	------------	---------

- Specify the IO value by changing the numerical value on the left or click on the IO lamp on the right, to configure the details of specific IO state. When the numerical value of the left is changed, the lamp on the right will automatically switch ON /OFF such that they are in the same IO state. Also, when the IO state of the lamps on the right are changed, the numerical values on the left will also change automatically.

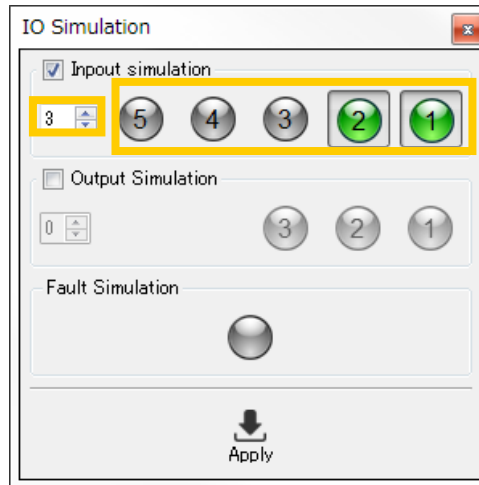

Fig 4.5-3 Input simulation numerical input and lamps

- If Apply is clicked then IO test starts.

[In case of fault simulation test]

- Click Fault simulation, confirm the lamp turns green.

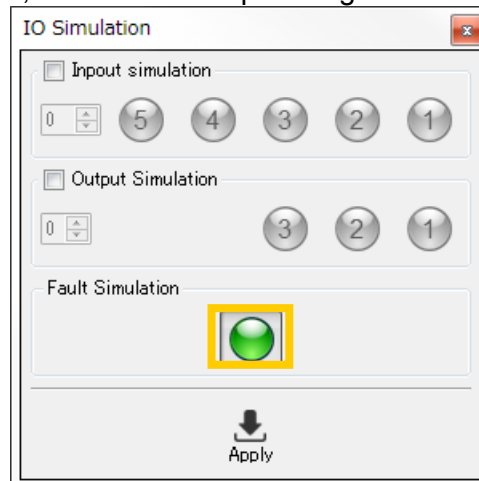

Fig 4.5-4 In the state of fault simulation lamp is led.

- If Apply is clicked then test starts.

Title	Area Designer Instruction Manual	Drawing NO	C-41-02495	36 / 51
-------	-------------------------------------	---------------	------------	---------

Caution

- After fault simulation test is done, the sensor will be in fault state temporarily. In order to return to the normal state from the test, restart the sensor and it is necessary to reconnect.
- When the input value is 0 and output value is 1 IO simulation cannot be done. It shows in Fig. 4.5-5 the display in such condition because laser is off in Area 0. During a laser off state, area configuration cannot be configured and detection determination is not possible either.

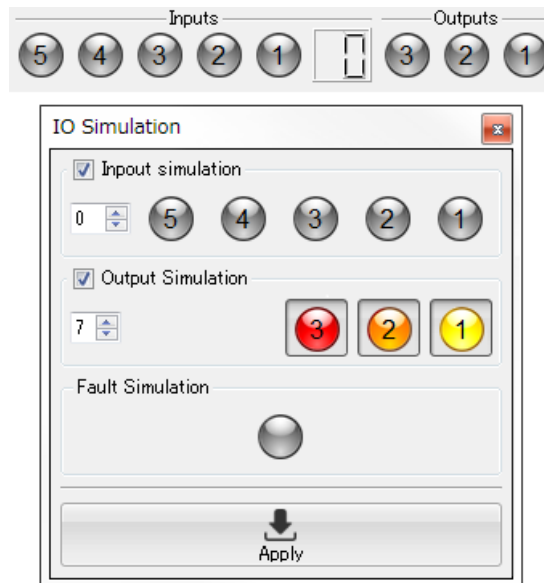

Fig 4.5-5 Display of IO lamps when IO simulation with the input value is 0

Title	Area Designer Instruction Manual	Drawing NO	C-41-02495	37 / 51
-------	-------------------------------------	---------------	------------	---------

4.6 Sensor information

When the sensor is connected this internal information of the sensor will be displayed.

Click connections in the menu bar → [**i** / sensor information] and the **i** icon in the tool bar will be active. When you click on the icon or press to the shortcut keys of “Ctrl + Shift + I”, the window illustrated in Fig. 4.6 will be displayed.

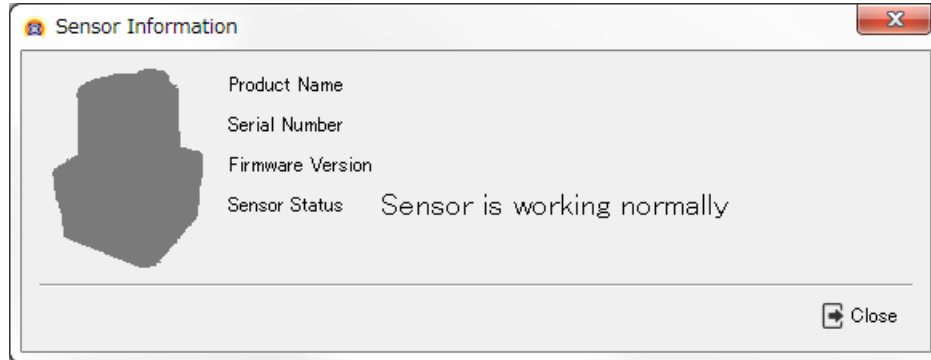

Fig 4.6 Sensor information

The details of the sensor information will be explained in Table 4.6.

Table 4.6 Display of sensor information

Name	Description
Sensor model	The product name of sensor model will be displayed.
Serial number	Serial number of the sensor will be displayed.
Firmware version	Firmware version of the sensor will be displayed.
Sensor status	Sensor status will be displayed.

4.7 Data Logging

This window is used to save the scanned data of the sensor. File extension is *.ubh. When sensor is connected, the ● icon in the toolbar will be active. Click the icon or press the shortcut keys of “Ctrl + 1”, and the window illustrated in Fig. 4.7 will be displayed. The details of this window will be explained in Table 4.7.

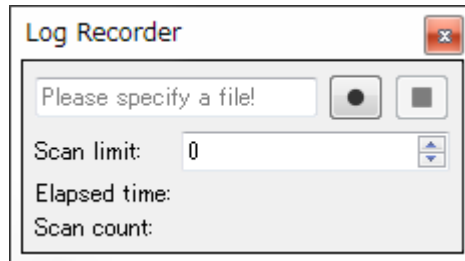



Fig 4.7 Data logging

Table 4.7 Display of data logging

Icon	Name	Description
●	Starts recording	Specify the location of record scanned data And starts recording.
■	Stops recording	Stops recording the log data.

When specifying the number of scans, enter the number of scans you want to record in the scan limit box and click the ● icon to start recording. After clicking the ● icon to start recording, then select the location. After location is selected, it starts recording. If the scan limit is 0, it records unit the ■ icon is clicked to stop.

4.8 Playing log data

This window is used for playing log data. (file extension: *.ubh). While sensor is disconnected, or when the measured distance display is stopped while connected to the sensor, play the log data and the  icon in the tool bar will be active. Click play the log data icon or use the shortcut keys of “Ctrl + 2”, and the window illustrated in Fig. 4.8-1 will be displayed.

The details of the cursor that is displayed within the “progress” of this window will be explained in Fig. 4.8-2. Also, the details of tool bar will be explained in Table 4.8.

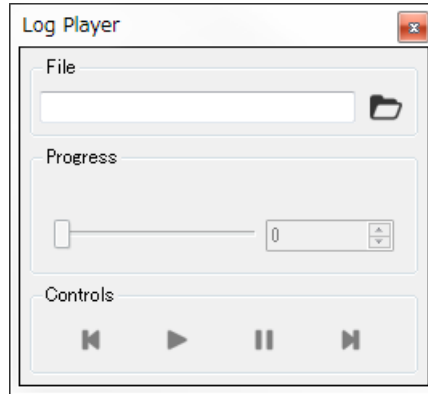

Fig 4.8-1 Log player

Cursor which operates play time of log data **Displays the scan number**

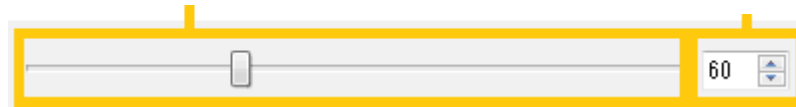







Fig 4.8-2 Cursor which operates play time of the log data

Table 4.8 Log player

Icon	Name	Description
	Open	Open and select the log data which you want to play. (file extension: *.ubh).File path will be displayed on the left when the file is selected.
	First	Moves to the initial position of log data.
	Play	Starts playing the log data.
	Pause	Pause/ Stops the log data for a while.
	Last	Moves to the end of log data.

Caution

- It is not possible to play log data and measurement display at the same time.
- In case you want to confirm the detection judgment of the area when playing log data, it is necessary to open the original project file used while recording the log data. Make sure to open the saved the project file.

4.9 About this application

This is used to confirm release information of the application. Click Help in the menu bar → [ / about this Application] or press the shortcut keys of “Ctrl + A”, as illustrated in Fig. 4.9 will be displayed.

Version indicates time and date when the application was released. Update details in each version of the application are listed in the update history.

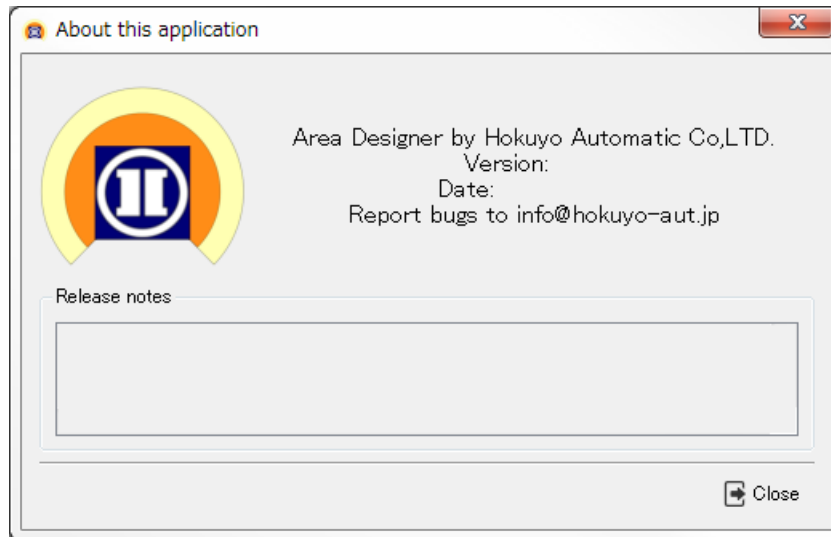

Fig 4.9 About this application

Title	Area Designer Instruction Manual	Drawing NO	C-41-02495	41 / 51
-------	-------------------------------------	---------------	------------	---------

5. Function of main screen window

5.1. Menu bar

The menu of this application is as displayed in Fig. 5.1. The details of each item of the menu are explained in the following chapters.

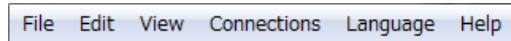

Fig 5.1 Menu bar

5.1.1 File

This menu is used for operating of project file and closing the application. This menu is displayed in Fig. 5.1.1. Also, the details of this menu are explained in Table 5.1.1.

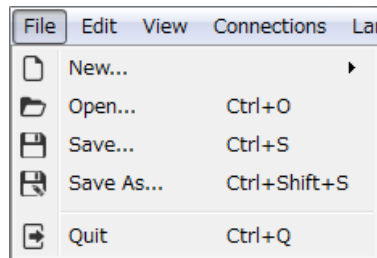







Fig 5.1.1 File

Table 5.1.1 File

Icon	Name	Shortcut	Description
	New		Create new project file.
	Open	Ctrl+O	Open an existing file.
	Save	Ctrl+S	Saves the project file. When the file is exists it overwrites the file.
	Save As	Ctrl+Shift+S	Save the project file after selecting name.
	Quit	Ctrl+Q	Close the application.

5.1.2 Edit

This menu is used for editing the area and application settings in edit mode. The edit menu is displayed as in Fig.5.1.2. Also, the details of edit menu are explained in Table 5.12.

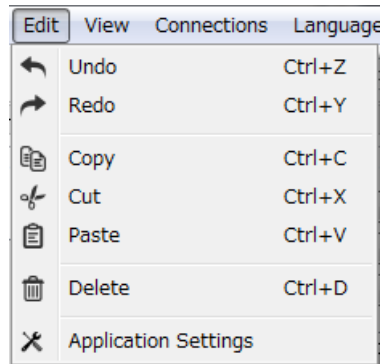

Fig 5.1.2 Edit

Table 5.1.2 Edit

Icon	Name	Shortcut	Description
	Redo	Ctrl+Z	It will undo the previous operation.
	Undo	Ctrl+Y	It will redo the last operation that was undone.
	Copy	Ctrl+C	Copy under the configuration area.
	Cut	Ctrl+X	Cut the selected area. Delete the original area.
	Paste	Ctrl+V	Paste the selected area in other area.
	Delete	Ctrl+D	Delete the selected area.

5.1.3 View

This menu is used to switch modes to edit or monitor and to display log data. This menu list is displayed in Fig.5.1.3-1. Also, the details of this menu list will be explained in Table 5.1.3-1.

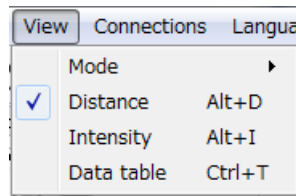

Fig 5.1.3-1 View

Table 5.1.3-1 View

Name	Shortcut	Function
Mode		Change/Switch the mode.
Distance	Alt+D	Display distance data as the measurement output data.
Intensity	Alt+I	Display intensity data as the measurement output data
Data table	Ctrl+T	Display data table.

In Fig.5.1.3-1 it displays the mode selection menu. In Fig. 5.1.3-2 it displays operation menu after the mode selection. Also, the details of this menu list are explained in Table 5.1.3-2.

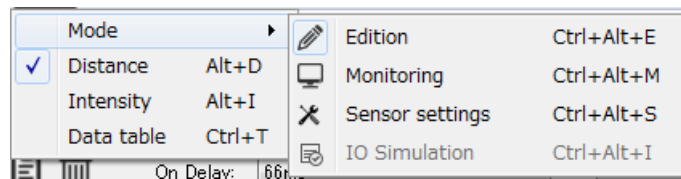





Fig 5.1.3-2 Mode selection

Table 5.1.3-2 Mode selection

Icon	Name	Shortcut	Description
	Edit	Ctrl+Alt+E	Changes to edit mode.
	Monitor	Ctrl+Alt+M	Changes to monitor mode.
	Sensor settings	Ctrl+Alt+S	Opens sensor setting.
	IO Simulation	Ctrl+Alt+I	Display IO Simulation.

5.1.4 Connections

This menu establishes communication with the connected sensor. The menu is displayed in Fig.5.1.4-1. Also, the details of this menu are explained in Table 5.1.4-1.

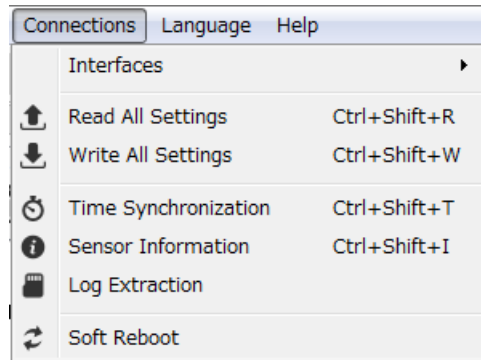

Fig 5.1.4-1 Connections

Table 5.1.4-1 Connections

Icon	Name	Shortcut	Description
	Interfaces		Change connection interfaces.
	Read all settings	Ctrl+Shift+R	Read all settings from sensor.
	Write all settings	Ctrl+Shift+W	Write all settings to sensor.
	Sensor information	Ctrl+Shift+I	Display sensor information.
	Soft reboot		Sensor restarts.

The Interface explained in Fig. 5.1.4-1 is displayed in Fig. 5.1.4-2. Also, the details of this menu will be explained in Table 5.1.4-2.

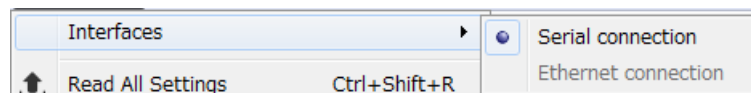

Fig 5.1.4-2 Interfaces

Table 5.1.4-2 Interfaces

Name	Description
Serial connection	Connect to serial connection

5.1.5 Language

This menu is used to change the displayed language of the application in English or Japanese. This menu list is displayed in Fig. 5.1.5. Also, the details of this menu are explained in Table 5.1.5.

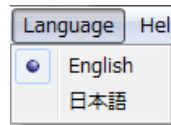

Fig 5.1.5 Language

Table 5.1.5 Language

Name	Description
English	Display in English language
日本語	Display in Japanese language

5.1.6 Help

This menu displays the instruction manual and application information. The Help menu is as shown in Fig 5.1.6. In table 5.1.6 it explains about this menu.

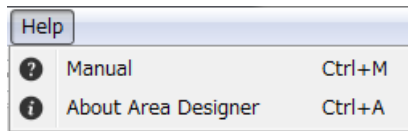

Fig 5.1.6 Help

Table 5.1.6 Help

Icon	Name	Shortcut	Description
?	Manual	Ctrl+M	Display application manual.
i	About Area Designer	Ctrl+A	Display about this application.

5.2. Toolbar

In Fig. 5.2 it displays toolbar of application. This toolbar consists of 4 toolbars sections and the details of each are explained in Table 5.2. The details of each individual toolbar section are explained in the following chapters.



Fig 5.2 Toolbar

Table 5.2 Toolbar

No.	Name of tool bar	Description
1	Basic tool	For the operation of project file and Redo/Undo operation.
2	Connection tool	Establish communication with the connected sensor.
3	Mode selection tool	Display mode selection and setting of each mode.
4	Measurement tool	Measurement display, record and play of log data.

5.2.1 Basic tool

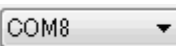







Table 5.2.1 Basic tool

Icon	Name	Shortcut	Description
	New		Create new project file.
	Open	Ctrl+O	Opens the existing project file.
	Save	Ctrl+S	Saves the edited project file. When a file is already specified, it overwrite data and saves.
	Undo	Ctrl+Z	It will undo the previous operation.
	Redo	Ctrl+Y	It will redo the last operation that was done.

Title	Area Designer Instruction Manual	Drawing NO	C-41-02495	47 / 51
-------	-------------------------------------	---------------	------------	---------





5.2.2 Connections tool

Table 5.2.2 Connection tool

Icon	Name	Shortcut	Description
	Serial COM Port		Display the COM port which has been connected.
	Rescan		Rescan the serial COM port and redisplay the connected COM port number.
	Select baud rate		Display the RS422 baud rate value.
	Connect device	Ctrl+Shift+C	Connects to COM port and communication takes place.
	Disconnect device	Ctrl+Shift+D	Disconnect the communication.
	Sensor information	Ctrl+Shift+I	Display sensor information.
	Read from sensor	Ctrl+Shift+R	Read the settings from the sensor.
	Write to sensor	Ctrl+Shift+W	Write settings to the sensor.





5.2.3 Mode selection tool

Table 5.2.3 Mode selection tool

Icon	Name	Shortcut	Description
	Edit	Ctrl+Alt+E	Change/Switch to edit mode.
	Monitor	Ctrl+Alt+M	Change/Switch to monitor mode.
	Sensor settings	Ctrl+Alt+S	Display sensor settings.
	IO Simulation	Ctrl+Alt+I	Display IO Simulation.

5.2.4 Measurement display tool

Table 5.2.4 Measurement display tool

Icon	Name	Shortcut	Description
	Play	Ctrl+0	Display the measurement data.
	Hide	Ctrl+0	Hide the measurement data.
	Record	Ctrl+1	Record log data.
	Replay	Ctrl+2	Play log data.

Caution

- In the event you want to confirm order the detection judgment order of the area when playing a log, it is necessary to open the original project file used while recording the log data. Make sure to save the project file.

Title	Area Designer Instruction Manual	Drawing NO	C-41-02495	48 / 51
-------	-------------------------------------	---------------	------------	---------

5.3. Main view toolbar

This toolbar is displayed in the bottom right of the main window. This toolbar is used for main view operations. The toolbar is as illustrated in Fig. 5.3. The details displayed in this tool bar are explained in Table 5.3.



Fig 5.3 Main view toolbar

Table 5.3 Main view toolbar

Icon	Name	Description
	Zoom out	Zoom out the main view screen. Same operation can be done by scrolling mouse down.
	Zoom in	Zoom In the main view screen. Same operation can be done by scrolling mouse up.
	Cursor	Move the cursor left for the zooming out. Move the cursor right for the zooming in.
	Zoom fit	Adjust the zoom so that the entire main view can be seen.
	Screen capture	Capture the main view, saves in PNG file.

5.4. Status bar

The status bar is displayed at the bottom of the main window. This status bar displays mouse related information and sensor information. The status bar is as illustrated in Fig. 5.4-1. Details displayed in this status bar, mouse related information is explained in Table 5.4-1. Sensor information is explained in Table 5.4-2. Communication status and recording status of display tools are explained in Table 5.4-3.

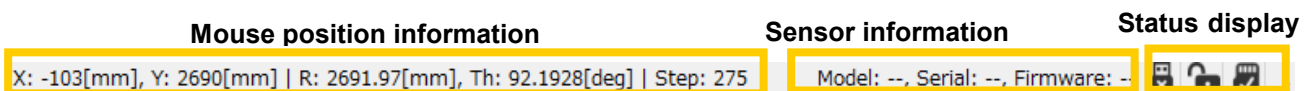

Fig 5.4-1 Status bar

X: -103[mm], Y: 2690[mm] | R: 2691.97[mm], Th: 92.1928[deg] | Step: 275

Fig 5.4-2 Mouse position Information

Title	Area Designer Instruction Manual	Drawing NO	C-41-02495	49 / 51
-------	-------------------------------------	---------------	------------	---------

Table 5.4-1 Display of mouse information

Display	Description
X	Displays the mouse position of x -coordinates.(unit: mm)
Y	Displays the mouse position of y -coordinates. (unit: mm)
R	“R” is for Radius. Distance from the origin to the position of the mouse is displayed. (unit :mm)
Th	“Th” is for Theta. Distance from the smallest angle to the position of mouse is displayed. (unit :deg)
Step	Display the step value of mouse position.







Model: --, Serial: --, Firmware: --

Fig.5.4-3 Sensor information

Table 5.4-2 Sensor information

Display	Description
Model	Model of the sensor will be displayed.
Serial	Serial number of the sensor is displayed.
Firmware	Firmware version of the sensor is displayed.

Table 5.4-3 Status display

Icon	Name	Description
	Sensor connected	Application displayed is connected with the sensor.
	Sensor disconnected	Application displayed is disconnected with the sensor.
	Protection state	When disconnected from the sensor or when switching to the monitoring screen while connected with the sensor.
	Non protection state	When connected to the sensor, switch to the editing screen
	Error state	Displays during fault simulations as it is not possible to do data logging.
	Data logging	Displays during data logging.
	During communication	Displays during communication processing.

Appendix A Network address

UXM-30LAH-EWA starts communication when Area Designer is connected with Ethernet. The default setting of sensor's IP address is 192.168.0.10. No need for special instruction as port number is fixed. Also, IP address can be changed by using other address changing tool.

Appendix B Troubleshooting

While using this application and if a problem occurs, refer to the following table.

In case a problem be cannot resolved with any of the following methods listed, note the situation and issue as well as when the problem occurred and contact the nearest sales representative or distributor.

Situation	Symptoms	Possible reason	Solution suggestion
When installing the application	Cannot install the application	Non-supported OS is used	Install in the OS supported computer.
		Free space of Hard disk is not sufficient	Free space of Hard disk must be more than 100MB.
		All windows program have not been closed	Close all the windows programs except installer.
	Installation process seems as stopped.	Installation process continuous	Please wait for a while. Depending on the computer, the installation process may require some time.
A message dialogue is displayed behind the displayed screen		Any hidden messages will be displayed by pressing the "Alt key" + the "Tab key", operate according to the message.	
When Sensor and PC connected	Could not find the sensor	Ethernet cable is not connected	Make sure that sensor is connected with the computer.
		Power supply is OFF.	Power supply to the sensor.

Title	Area Designer Instruction Manual	Drawing NO	C-41-02495	51 / 51
-------	-------------------------------------	---------------	------------	---------

