

Panel connector, Ø8mm snap, male, straight, 4 poles, print contact

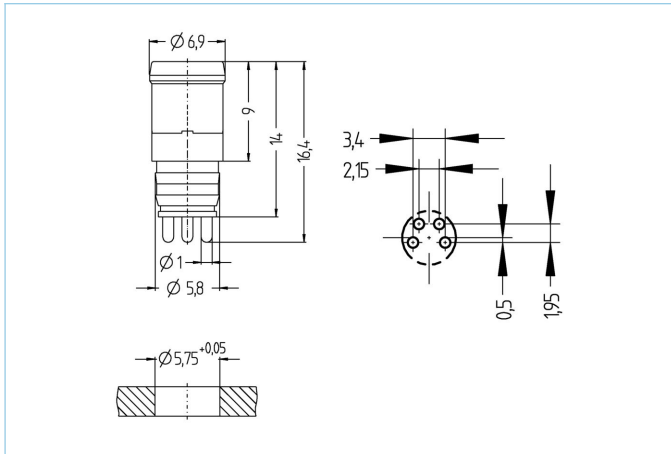

Product data	
Item description	ESHP4P
Item-No.	8008160
Customs tariff-No.	85366990
Step-File	ESHP4P.stp
EAN	4047106094089
Technical data	
Connector	male, Ø8mm snap
Number of pins	4
Rated voltage	60V
Current load per pin (at 40°C)	4A
Insulation resistance	≥10 ⁹ Ω
Ambient temperature product	-30°C...+90°C
Contact material	Metal, CuZn, gold-plated
Contact-carrier material	Plastic, PA, transparent
Connecting type	Print contact
Standards	IEC 61076-2-104
Degree of protection (mounted)	IP65, IP67
Mechanical life-cycle	>100 mating cycles
Degree of pollution	3/2
Style	straight
Classification	
eCl@ss 6.0	27279220
eCl@ss 7.0	27440103
eCl@ss 8.0	27440103
eCl@ss 9.0	27440103
ETIM 5.0	EC002061
ETIM 6.0	EC002061

Link to product

<https://www.escha.net/en/products/standard/receptacles/8008160>