

Receptacle, M12, female, angled, 4 poles, D-coded, back wall-mounting, print contact, shielded, Industrial Ethernet

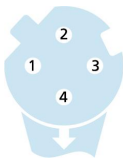
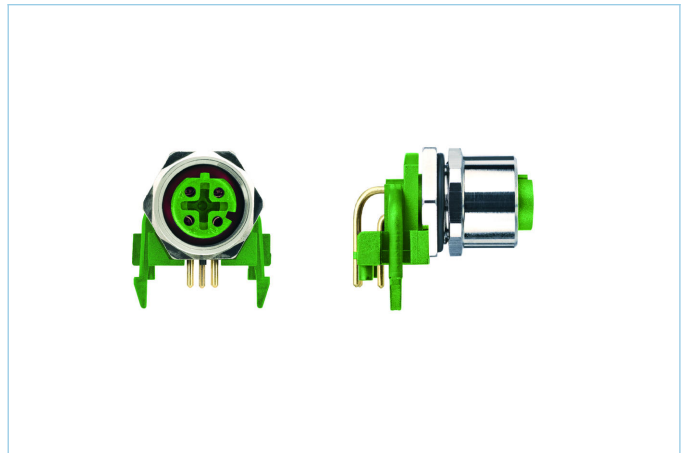
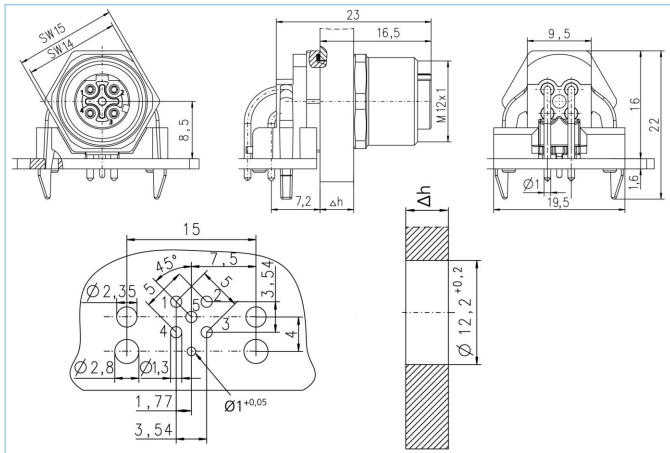

**Product data**

Item description	IE-WFKFSY4-P/12/S3525
Item-No.	8050282
Customs tariff-No.	85366990
Packaging unit	10
Step-File	IE-WFKFSY4-P_12_S3525.stp
EAN	4047106010096

**Technical data**

Connector	female, angled, M12
Number of pins	4
Coding	D
Rated voltage	250V
Current load per pin (at 40°C)	4A
Insulation resistance	≥10 <sup>9</sup> Ω
Ambient temperature product	-30°C...+90°C
Contact material	Metal, CuZn, gold-plated
Contact-carrier material	Plastic, PA, GN
Receptacle housing material	Metal, CuZn, nickel-plated
Sealing (female) material	FPM/FKM
Material of external sealing	NBR
Shielding	with shielding
Mounting direction	Back wall-mounting (incl. Fixing screw)
Wrench size of fastening nut	A/F14
Wall thickness area (Δh)	1,0...2,5 mm
Connecting type	Print contact
Fastening thread	M12x1

Standards	IEC 61076-2-101
Degree of protection (mounted)	IP65, IP67, IP68
Mechanical life-cycle	>100 mating cycles
Degree of pollution	3
Style	angled

#### Advanced technical data rail approved

Standards	DIN EN 50155, DIN EN 45545-2
Shock & vibration	Class 1, Category B (DIN EN 61373)
Degree of protection (mounted)	IP67 (-30°C...+90°C), IP65 (-40°C...+90°C)
Temperature range	Tx (-40°C...+90°C)
Fire prevention according to	DIN EN 45545-2 HL1-3

#### Classification

eCl@ss 6.0	27279220
eCl@ss 7.0	27440103
eCl@ss 8.0	27440103
eCl@ss 9.0	27440103
ETIM 5.0	EC002061
ETIM 6.0	EC002061

#### Link to product

<https://www.escha.net/en/products/standard/receptacles/8050282>