

M12, male, angled, 8 poles, X-coded, M12, male, straight, 8 poles, X-coded, shielded, Industrial Ethernet 10 GBit/s

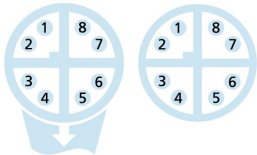

PROFI
NET

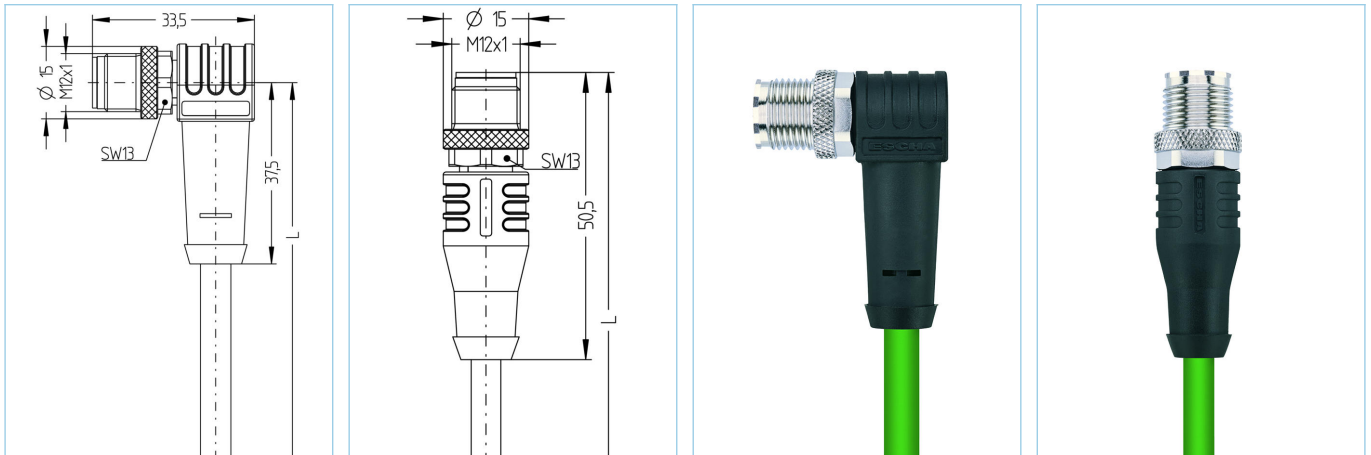

Product data

Item description	IE-WWASSX8.066-5-IE-WASSX8.066/S3500
Item-No.	8055446
Length	5m
Customs tariff-No.	85444290
Step-File	IE-WWASSX8-L-IE-WASSX8_S3500.stp
EAN	4047106139353
Label-carrier	2 pieces

Technical data	A-side	B-side
Connector	male, angled, M12	male, straight, M12
Number of pins	8	8
Pin assignment	1 WHOG, 2 OG; 3 WHGN, 4 GN; 5 WHBN, 6 BN; 7 WHBU, 8 BU	1 WHOG, 2 OG; 3 WHGN, 4 GN; 5 WHBN, 6 BN; 7 WHBU, 8 BU
Coding of	X	X
Rated voltage	50V _{AC} 60V _{DC}	50V _{AC} 60V _{DC}
Current load (at 40°C)	0.5A	0.5A
Insulation resistance	≥10 ⁹ Ω	≥10 ⁹ Ω
Resistance	≤ 5mΩ	≤ 5mΩ
Transmission features	Cat6A	Cat6A
Ambient temperature product	-30°C...+90°C	-30°C...+90°C
Contact material	Metal, CuSn, gold-plated	Metal, CuSn, gold-plated
Contact-carrier material	Plastic, PA GF, BK	Plastic, PA GF, BK
Grip body material	Plastic, TPU, BK	Plastic, TPU, BK
Coupling nut material	Metal, CuZn, nickel-plated	Metal, CuZn, nickel-plated
Shielding	with shielding	with shielding
Standards	IEC 61076-2-109	IEC 61076-2-109
Degree of protection (mounted)	IP65, IP67, IP68	IP65, IP67, IP68
Mechanical life-cycle	>100 mating cycles	>100 mating cycles
Degree of pollution	2	2

Advanced technical data UL

Rated voltage	30V _{AC/DC}
Rated current	0,5A

Cable Cat7, PUR, UL, S3500

Shielded PUR-cable for industrial applications. The cable meets the UL-Style 20963 and the Cat7 (electrical properties according to EN50288-4-2) requirements. Materials and a constructive setup allow for increased mechanical stresses (abrasion, bending, vibrations etc.) of the cable.

Outer diameter of jacket	6.40 mm
Cable-jacket material	PUR
Jacket color	GN, similar RAL6018
Wire cross-section	4 x 2 x 0.14 mm ²
Wire insulation material	PE
Wire colors	WH/OG ; WH/GN ; WH/BN ; WH/BU
Wire structure	7 x 0.16 mm
Bending radius (fixed)	5 x Ø-cable
Bending radius (repeated)	10 x Ø-cable
Temperature range (repeated)	-20°C...+60°C
Temperature range (fixed)	-40°C...+80°C
Shielding	Yes
Halogen-free	Yes
Transmission features	Cat7
Rated voltage cable	30 V UL rating
Special features	seawater resistant, recyclable, LABS free, RoHs compliant, acid- and alkali resistant, UV resistant, hydrolysis proof, halogen free, oil resistant, high flexibility, no corrosive gases, microbes resistant, no fire propagation

Classification

eCl@ss 6.0	27060307
eCl@ss 7.0	27060307
eCl@ss 8.0	27060307
eCl@ss 9.0	27060307
ETIM 5.0	EC000830
ETIM 6.0	EC000830

Accessories

Mounting-set, M12

<https://www.escha.net/en/products/standard/accessories-for-connectivity/8047664>

Torque-wrench set

<https://www.escha.net/en/products/standard/accessories-for-connectivity/8055431>

Marking rings Ø 9mm

<https://www.escha.net/en/products/standard/accessories-for-connectivity/?p=1&o=3&n=15&f=809>

Link to product

<https://www.escha.net/en/products/standard/data-connectors/8055446>