

M8, male, angled, 4 poles, M8, male, angled, 4 poles, shielded, Industrial Ethernet

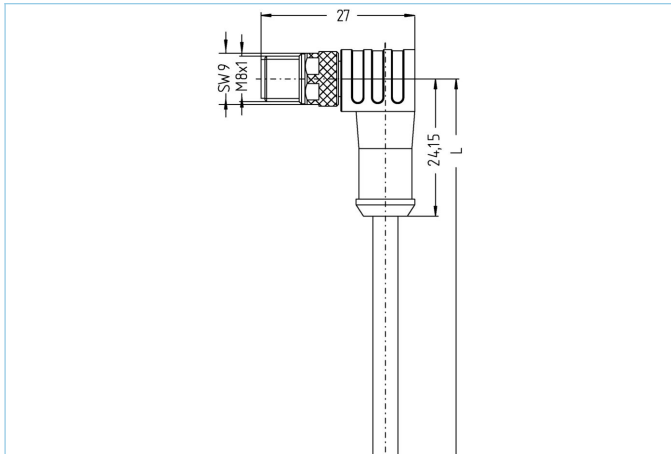

Product data	
Item description	IE-SWSPS4.027-2-IE-SWSPS4.027/S3400
Item-No.	8055802
Length	2m
Customs tariff-No.	85444290
Step-File	IE-SWSPS4-m-IE-SWSPS4.stp
EAN	4047106141080
Label-carrier	2 pieces

Technical data	A-side	B-side
Connector	male, angled, M8	male, angled, M8
Number of pins	4	4
Pin assignment	1 WHOG, 2 WHBU, 3 BU, 4 OG	1 WHOG, 2 WHBU, 3 BU, 4 OG
Rated voltage	60V	60V
Current load (at 40°C)	4A	4A
Insulation resistance	≥10 ⁹ Ω	≥10 ⁹ Ω
Transmission features	Cat5e	Cat5e
Ambient temperature product	-30°C...+90°C	-30°C...+90°C
Contact material	Metal, CuSn, gold-plated	Metal, CuSn, gold-plated
Contact-carrier material	Plastic, PA, BK	Plastic, PA, BK
Grip body material	Plastic, TPU, BK	Plastic, TPU, BK
Coupling nut material	Metal, CuZn, nickel-plated	Metal, CuZn, nickel-plated
Shielding	with shielding	with shielding
Standards	IEC 61076-2-104	IEC 61076-2-104
Degree of protection (mounted)	IP65, IP67, IP68	IP65, IP67, IP68
Mechanical life-cycle	>100 mating cycles	>100 mating cycles
Degree of pollution	3/2	3/2

Cable Cat5e, PUR, UL, S3400

Shielded PUR Ethernet-cable for industrial applications. Fits to real-time requirements according to IEC61158. The cable meets the UL-Style 21815 (80°/300V)- and the Cat5 (electrical properties according to EN50288-2-2) requirements. Materials and a constructive setup for increased mechanical stresses (abrasion, bending, vibrations etc.) of the cable. Drag-chain/torsion operations are possible. High tensile strength through incorporated Kevlar-strands.

Outer diameter of jacket	4.80 mm
Cable-jacket material	PUR
Jacket color	GN, similar RAL6018
Wire cross-section	1 x 4 x AWG26, star quad
Wire insulation material	PP
Wire colors	WHBU/BU, WHOG/OG
Wire structure	19 x 0.10 mm
Bending radius (fixed)	4 x Ø-cable
Bending radius (repeated)	7,5 x Ø-cable
Temperature range (fixed)	-40°C...+80°C
Transmission features	Cat5
Rated voltage cable	300 V UL rating
Special features	seawater resistant, recyclable, LABS free, RoHs compliant, acid- and alkali resistant, ozone resistant, UV resistant, hydrolysis proof, drag chain-adapted, halogen free, oil resistant, high flexibility, microbes resistant

Classification

eCl@ss 6.0	27060307
eCl@ss 7.0	27060307
eCl@ss 8.0	27060307
eCl@ss 9.0	27060307
ETIM 5.0	EC000830
ETIM 6.0	EC000830

Accessories

Mounting-set, M8

<https://www.escha.net/en/products/standard/accessories-for-connectivity/8047663>

Torque-wrench set

<https://www.escha.net/en/products/standard/accessories-for-connectivity/8055431>

Marking rings Ø 9mm

<https://www.escha.net/en/products/standard/accessories-for-connectivity/?p=1&o=3&n=15&f=809>

Link to product

<https://www.escha.net/en/products/standard/data-connectors/8055802>