

M8, female, angled, 3 poles, M8, male, angled, 3 poles, Food & Beverage

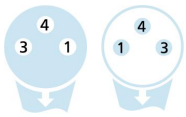
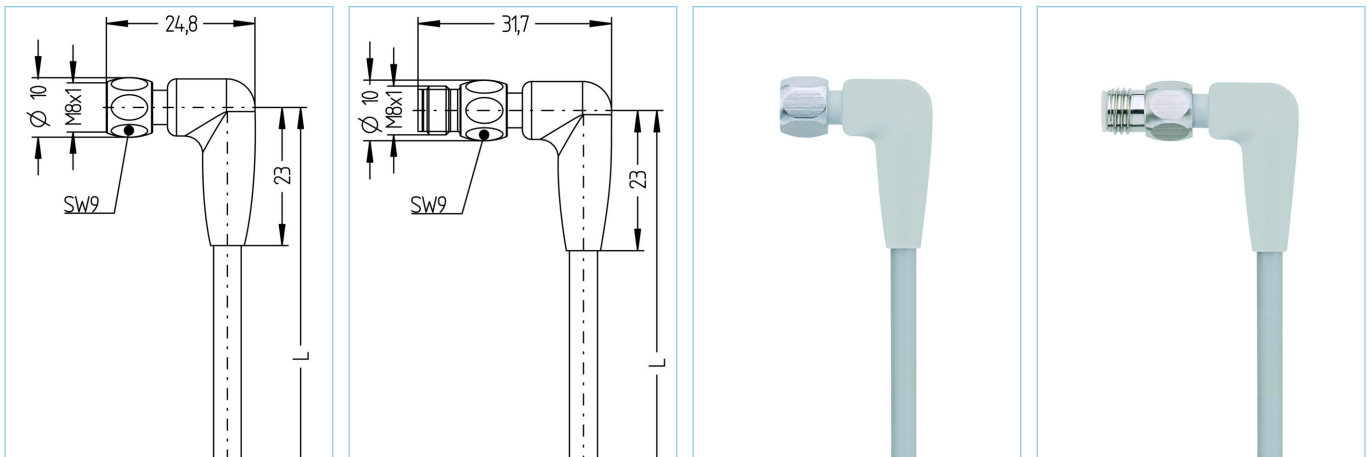

Product data

Item description	FB-SWKPH3-2-FB-SWSPH3/S3930
Item-No.	8058606
Length	2m
Customs tariff-No.	85444290
Step-File	FB-SWKPH3-L-FB-SWSPH3.stp
EAN	4047106142377

Technical data	A-side	B-side
Connector	female, angled, M8	male, angled, M8
Number of pins	3	3
Pin assignment	1 BN, 3 BU, 4 BK	1 BN, 3 BU, 4 BK
Rated voltage	60V	60V
Current load (at 40°C)	4A	4A
Insulation resistance	≥10 ⁹ Ω	≥10 ⁹ Ω
Ambient temperature product	-40°C...+105°C	-40°C...+105°C
Contact material	Metal, CuZn, gold-plated	Metal, CuZn, gold-plated
Contact-carrier material	Plastic, PP, GY	Plastic, PP, GY
Grip body material	Plastic, PP, GY	Plastic, PP, GY
Coupling nut material	Stainless steel, V4A	Stainless steel, V4A
Sealing (female) material	EPDM	
Standards	IEC 61076-2-104	IEC 61076-2-104
Degree of protection (mounted)	IP65, IP67, IP68, IP69	IP65, IP67, IP68, IP69
Mechanical life-cycle	>100 mating cycles	>100 mating cycles
Degree of pollution	3	3

Cable TPE, S3930, GY

TPE jacketed cable with elevated position-proof wires with an insulation of special polyester. Resistant to all common acidic- and alkaline cleaning- and disinfection agents. PVC-free plastics prevent discoloration and hardening by detergents. Predestined for applications in the food- and beverage industry. Due to the materials used, it is also suitable for applications in machine- and plant construction. High stability, good drag-chain- and torsion capability.

Outer diameter of jacket	4.60 mm
Cable-jacket material	TPE
Jacket color	GY, similar RAL7035
Wire cross-section	4 x 0.34 mm ²
Wire insulation material	TPE
Wire colors	BN, WH, BU, BK
Wire structure	42 x 0.10 mm
Bending radius (fixed)	5 x Ø-cable
Bending radius (repeated)	10 x Ø-cable
Temperature range (repeated)	-25°C...+105°C
Temperature range (fixed)	-40°C...+105°C
Temperature range (drag chain)	-25°C...+60°C
Halogen-free	Yes
Rated voltage cable	≤240 V _{AC}
Special features	seawater resistant, recyclable, LABS free, RoHs compliant, ozone resistant, hydrolysis proof, drag chain-adapted, torsion resistant, halogen free, excellent acid- and alkali resistant, verified resistance against P3-topactive, flexibility at low temperature, increased thermal load

Classification

eCl@ss 6.0	27279218
eCl@ss 7.0	27279218
eCl@ss 8.0	27279218
eCl@ss 9.0	27060311
ETIM 5.0	EC001855
ETIM 6.0	EC001855

Accessories
Mounting-set, M8

<https://www.escha.net/en/products/standard/accessories-for-connectivity/8047663>

Torque-wrench set

<https://www.escha.net/en/products/standard/accessories-for-connectivity/8055431>

Marking rings Ø 9mm

<https://www.escha.net/en/products/standard/accessories-for-connectivity?p=1&o=3&n=15&f=809>

Link to product

<https://www.escha.net/en/products/standard/connectors-for-the-food-industry/8058606>