

I/O-junctions passive, 10 ports, fixed cable connection, Ø8mm snap, female, 3 poles

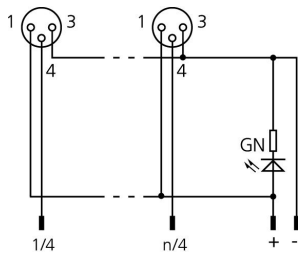
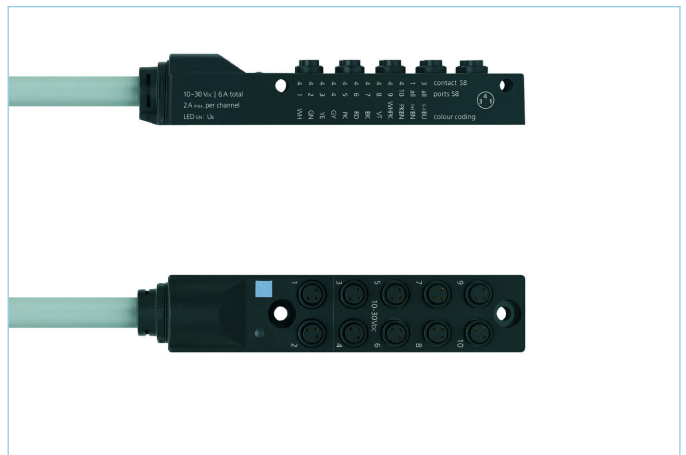
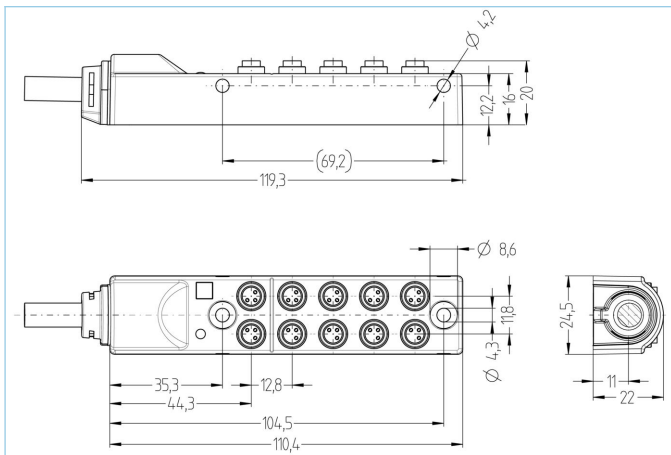

Product data

Item description	10I/OS8-3P1C-2/P01
Item-No.	8062838
Length	2m
Customs tariff-No.	85444290
Step-File	10I_OS8-3P1C-m.stp
EAN	4047106149031

Technical data

I/O-junction	10-way, with cable
I/O-slot	female, 8 mm snap
Number of pins	3
Rated voltage	30V
Current load per pin (at 40°C)	2A
Total current load	6A
Insulation resistance	≥10 ⁸ Ω
Resistance	≤ 5mΩ
Ambient temperature product	-30°C...+90°C
Number of LEDs	1
Number of I/O-slots	10
Circuit logic	npn
Signal status-indicator	LED YE
Operating voltage-indicator	LED GN
Contact material	Metal, CuZn, gold-plated
Contact-carrier material	Plastic, PA, BK
Sealing (female) material	FPM/FKM
Housing material	Plastic, PA, BK
Connecting type	Fixed cable connection

Thread insert material	Metal, CuZn
Standards	IEC 61076-2-104
Degree of protection (mounted)	IP65, IP67
Mechanical life-cycle	>100 mating cycles
Degree of pollution	3

Cable	PVC, UL, P01, GY
--------------	-------------------------

PVC-cable for measurement and control-, and sensor technology. Suitable for applications in dry areas on packaging machines, assembly- and conveyor technology. High flexibility with unstressed movement (conditional drag-chain application possible). Predestined for applications in food- and beverage industry.

Outer diameter of jacket	7.6 mm
Cable-jacket material	PVC
Jacket color	GY, similar RAL7040
Wire cross-section	10 x 0.25 mm ² + 2 x 0.75 mm ²
Wire insulation material	PVC
Wire colors	WHPK, BK, BU, PK, WH, YE, GN, GY, PKBN, RD, BN, VT
Wire structure	32 x 0.10 mm
Bending radius (fixed)	5 x Ø-cable
Bending radius (repeated)	10 x Ø-cable
Temperature range (repeated)	-5°C...+80°C
Temperature range (fixed)	-40°C...+80°C
Special features	seawater resistant, recyclable, LABS free, RoHs compliant, acid- and alkali resistant, ozone resistant, UV resistant

Allocation chart

I/O	1	2	3	4	5	6	7	8	9	10	all (+)	all (-)
Pin	4	4	4	4	4	4	4	4	4	4	1	3
Cable	WH	GN	YE	GY	PK	RD	BK	VT	WHPK	BNPK	BN	BU

Classification

eCl@ss 6.0	27279219
eCl@ss 7.0	27279219
eCl@ss 8.0	27279219
eCl@ss 9.0	27440108
ETIM 5.0	EC002585
ETIM 6.0	EC002585

Link to product

<https://www.escha.net/en/products/standard/io-junctions/8062838>