

## M12, female, straight, 5 poles, Food & Beverage

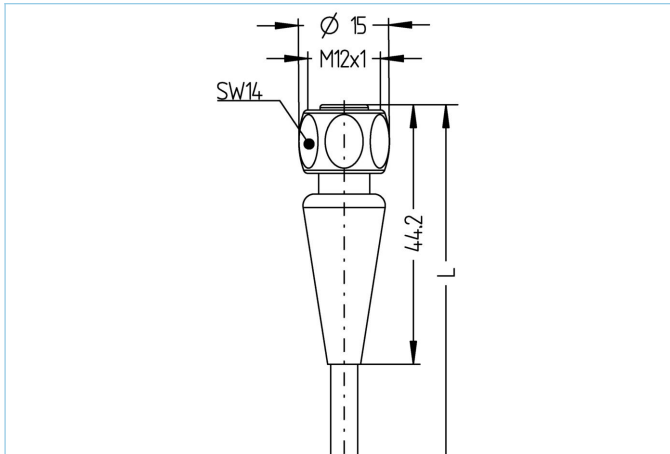

### Product data

Item description	FB-WAKH4.5-2/P00
Item-No.	8063817
Length	2m
Customs tariff-No.	85444290
Step-File	FB-WAKH4_5.stp
EAN	4047106151287

### Technical data

Connector	female, straight, M12
Number of pins	5
Pin assignment	1 BN, 2 WH, 3 BU, 4 BK, 5 GY
Coding	A
Rated voltage	60V
Current load per pin (at 40°C)	4A
Insulation resistance	$\geq 10^9 \Omega$
Resistance	$\leq 5 m\Omega$
Ambient temperature product	-40°C...+105°C
Contact material	Metal, CuZn, gold-plated
Contact-carrier material	Plastic, PP, GY
Grip body material	Plastic, PP, GY
Coupling nut material	Stainless steel, V4A
Sealing (female) material	EPDM
Standards	IEC 61076-2-101
Degree of protection (mounted)	IP65, IP67, IP68, IP69
Mechanical life-cycle	>100 mating cycles
Cable end assembly	open cable end
Degree of pollution	3
Style	straight

<b>Cable</b>	<b>PVC, P00, GY</b>
--------------	---------------------

PVC-cable for measurement and control-, and sensor technology. Suitable for applications in dry areas on packaging machines, assembly- and conveyor technology. High flexibility with unstressed movement (conditional drag-chain application possible). Predestined for applications in food- and beverage industry.

Outer diameter of jacket	4.90 mm
Cable-jacket material	PVC
Jacket color	GY, similar RAL7040
Wire cross-section	5 x 0.34 mm <sup>2</sup>
Wire insulation material	PVC
Wire colors	BN, WH, BU, BK, GY
Wire structure	19 x 0.15 mm
Bending radius (fixed)	5 x Ø-cable
Bending radius (repeated)	10 x Ø-cable
Temperature range (repeated)	0°C...+80°C
Temperature range (fixed)	-25°C...+80°C
Rated voltage cable	≤300 V
Special features	seawater resistant, recyclable, LABS free, RoHs compliant, acid- and alkali resistant, ozone resistant, UV resistant

<b>Classification</b>	
-----------------------	--

eCl@ss 6.0	27279218
eCl@ss 7.0	27279218
eCl@ss 8.0	27279218
eCl@ss 9.0	27060311
ETIM 5.0	EC001855
ETIM 6.0	EC001855

<b>Accessories</b>	
--------------------	--

Mounting-set, M12 <a href="https://www.escha.net/en/products/standard/accessories-for-connectivity/8047664">https://www.escha.net/en/products/standard/accessories-for-connectivity/8047664</a>	
Torque-wrench set <a href="https://www.escha.net/en/products/standard/accessories-for-connectivity/8055431">https://www.escha.net/en/products/standard/accessories-for-connectivity/8055431</a>	
Marking rings Ø 9mm <a href="https://www.escha.net/en/products/standard/accessories-for-connectivity/?p=1&amp;o=3&amp;n=15&amp;f=809">https://www.escha.net/en/products/standard/accessories-for-connectivity/?p=1&amp;o=3&amp;n=15&amp;f=809</a>	
Cable Stripping Tool <a href="https://www.escha.net/en/products/standard/accessories-for-connectivity/8066215">https://www.escha.net/en/products/standard/accessories-for-connectivity/8066215</a>	
Cable Stripping Tool <a href="https://www.escha.net/en/products/standard/accessories-for-connectivity/8066216">https://www.escha.net/en/products/standard/accessories-for-connectivity/8066216</a>	
Food & Beverage, Adapter <a href="https://www.escha.net/en/products/standard/accessories-for-connectivity/8063392">https://www.escha.net/en/products/standard/accessories-for-connectivity/8063392</a>	

<b>Link to product</b>	
------------------------	--

<https://www.escha.net/en/products/standard/connectors-for-the-food-industry/8063817>