

M8, female, straight, 8 poles, M8, male, angled, 8 poles, shielded, sensor-/actuator cable

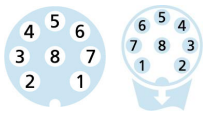
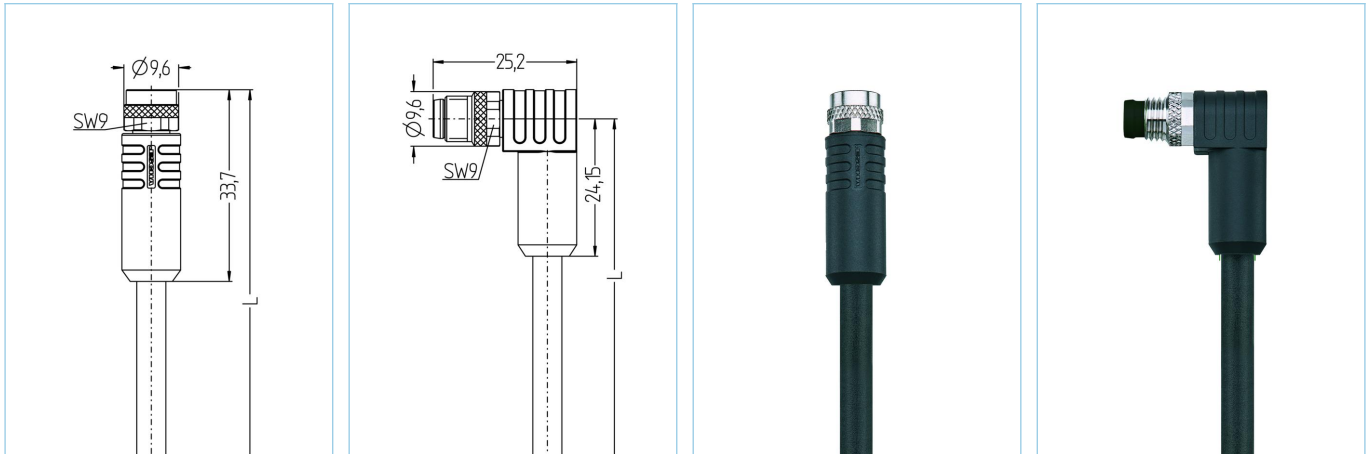

Product data

Item description	AL-SKPS8-2-AL-SWSPS8/S370
Item-No.	8115017
Length	2m
Customs tariff-No.	85444290
Step-File	AL-SKPS8-m-AL-SWSPS8.stp
EAN	4047106317461
Label-carrier	2 pieces

Technical data	A-side	B-side
Connector	female, straight, M8	male, angled, M8
Number of pins	8	8
Pin assignment	1 WH, 2 BN, 3 GN, 4 YE, 5 GY, 6 PK, 7 BU, 8 RD	1 WH, 2 BN, 3 GN, 4 YE, 5 GY, 6 PK, 7 BU, 8 RD
Rated voltage	30V	30V
Current load (at 40°C)	1.5A	1.5A
Insulation resistance	$\geq 10^8 \Omega$	$\geq 10^8 \Omega$
Resistance	$\leq 5 m\Omega$	$\leq 5 m\Omega$
Ambient temperature product	-30°C...+90°C	-30°C...+90°C
Contact material	Metal, CuZn, gold-plated	Metal, CuZn, gold-plated
Contact-carrier material	Plastic, TPU, BK	Plastic, TPU, BK
Grip body material	Plastic, TPU, BK	Plastic, TPU, BK
Coupling nut material	Metal, CuZn, nickel-plated	Metal, CuZn, nickel-plated
Sealing (female) material	FPM/FKM	
Shielding	with shielding	with shielding
Standards	IEC 61076-2-104	IEC 61076-2-104
Degree of protection (mounted)	IP65, IP67, IP68	IP65, IP67, IP68
Mechanical life-cycle	>100 mating cycles	>100 mating cycles
Degree of pollution	3	3

Cable	PUR, UL, S370
--------------	----------------------

Flexible, silicone- and halogen-free control cable with high mechanical strength. The cable is chemicals, hydrolysis-, and microbes-resistant. The drag-chain application is possible at a bending radius of minimum $10 \times d$. Due to its weld-field immunity, the cable is very well suited for the flexible application in robotics, machine-tool, and metal-cutting production. The cables meet the UL and CSA (UL10493/20549; cULus) requirements. Very good EMC-features with shielded versions.

Outer diameter of jacket	6.30 mm
Cable-jacket material	PUR
Jacket color	BK, similar RAL9005
Wire cross-section	8 x 0.25 mm ²
Wire insulation material	PP
Wire colors	WH, BN, GN, YE, GY, PK, BU, RD
Wire structure	32 x 0.10 mm
Bending radius (fixed)	5 x Ø-cable
Bending radius (repeated)	12 x Ø-cable
Temperature range (repeated)	-30°C...+90°C
Temperature range (fixed)	-40°C...+90°C
Temperature range (drag chain)	-25°C...+60°C
Drag chain-application	≥2 Mio. cycles
Shielding	Yes
Halogen-free	Yes
Torsion	+/-180°/m, ≥ 0.5 Mio. cycles
Rated voltage cable	≤300 V
Special features	flame retardant, halogen free, hydrolysis proof, LABS free, oil resistant, ozone resistant, recyclable, RoHs compliant, acid- and alkali resistant, drag chain-adapted, welding sparks resistant, seawater resistant, silicone free, torsion resistant, UV resistant

Classification	
-----------------------	--

eCl@ss 6.0	27279218
eCl@ss 7.0	27279218
eCl@ss 8.0	27279218
eCl@ss 9.0	27060311
ETIM 5.0	EC001855
ETIM 6.0	EC001855

Accessories	
--------------------	--

Mounting-clip, M8 https://www.escha.net/en/products/standard/accessories-for-connectivity/8047658	
Torque-wrench set https://www.escha.net/en/products/standard/accessories-for-connectivity/8055431	
Screw plug, M8 https://www.escha.net/en/products/standard/accessories-for-connectivity/8081771	
Screw cap, M8 https://www.escha.net/en/products/standard/accessories-for-connectivity/8081761	

Link to product	
------------------------	--

https://www.escha.net/en/products/standard/sensoractuator-connectors/B115017	
---	--