



Product Description

The insulation monitor LK 5896 of the varimeter IMD family provides best insulation monitoring of modern IT systems in an optimum and state of the art way, fulfilling the relevant standards. The device can be used in the most flexible way for AC, DC and AC/DC systems even with large leakage capacity to earth (PE). The adjustment of the setting values is simple and user friendly done on 2 rotary switches on the front of the device. Via LEDs the measured value, device parameters and device status are indicated easy to read. The unit has 3 relay contacts to signal Insulation and device failures. The analogue output provides a voltage and current signal proportional to the actual insulation resistance, which can be connected to a superior control (plc), another system or external display unit. In addition the LK 5896 provides a second measuring circuit that can be used to monitor an inverter on the AC side also when the inverter is disconnected.

Your Advantages

- Preventive fire and system protection
- Quick fault localisation through selective earth fault detection to L+ and L-
- Universal application in non-earthed AC, DC, AC/DC networks with up to 1000 V nominal voltage
- Suitable for large leakage capacitances up to 3000 µF
- Simplest setting via engaging rotary switches
- For monitoring photovoltaic system, also with thin-film technology
- Optimised measuring times - normally shorter than with known methods
- Monitoring also with voltage-free mains
- Additional measuring circuit allows AC output monitoring even with the inverter switched off, e.g. with hybrid vehicles
- Measuring circuit with broken wire detection
- No additional coupling device required
- Trigger output for insulation fault locating system
- Analogue output for value of the insulation resistance: 0 ... 10 V / 0 ... 20 mA (2 ... 10 V / 4 ... 20 mA)

Features

- Insulation monitoring according to IEC/EN 61557-8
- Detection of symmetric and asymmetric insulation faults
- Measuring circuits can be disconnected via control terminals, e.g. for mains couplings
- 1 changeover contact each for prewarning and alarm
- 3. output relay for signalling wire break and device faults
- Prewarning threshold setting range: 20 kΩ ... 2 MΩ
- Alarm threshold setting range: 1 kΩ ... 250 kΩ
- Energized or de-energized on trip can be selected for output relay
- Setting the maximum leakage capacitance to shorten the response time
- Simple, clearly arranged adjustment of the device with screwdriver
- LED chain to indicate the current insulation resistance
- Display of active measuring circuits
- Automatic and manual device self-test
- Alarm storage selectable
- External test and reset pushbutton can be connected
- Width: 90 mm

Connection Terminals

Terminal designation	Signal description
A1+, A2	DC-Auxiliary voltage
L(+), L(-)	Connection for main measuring circuit
U, V	Connection for auxiliary measuring circuit
KE, PE	Connection for protective conductor
G, R	Control input (manual/auto reset) G/R not bridged: Manual reset G/R bridged: Auto reset
G, T	Control input (External test input) connection option for external device test pushbutton
G, HM	Control input (main measuring circuit deactivation) G/HM not bridged: Main measuring circuit activated G/HM bridged: Main measuring circuit deactivated
G, ZM	Control input (aux. measuring circuit deactivation) G/ZM not bridged: Aux. measuring circuit deactivated G/ZM bridged: Aux. measuring circuit activated
XA, GA, IA, UA	Analogue output XA/GA not bridged: UA-GA 0 ... 10V; IA-GA 0 ... 20mA XA/GA bridged: UA-GA 2 ... 10V; IA-GA 4 ... 20mA
Y1, Y2	Alarm trigger output for insulation fault locating system
11, 12, 14	Alarm signal relay (1 changeover contact)
21, 22, 24	Prewarning signal relay (1 changeover contact)
31, 32, 34	Device fault signal relay (1 changeover contact)

Approvals and Markings

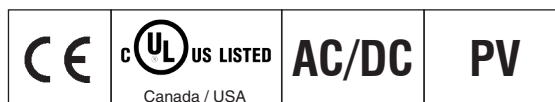

Applications

- Insulation monitoring of:
- Non-earthed AC, DC, AC/DC networks
 - UPS systems
 - Networks with frequency inverters
 - Battery networks
 - Networks with direct current drives
 - Photovoltaic systems
 - Hybrid and battery-powered vehicles

Circuit Diagrams

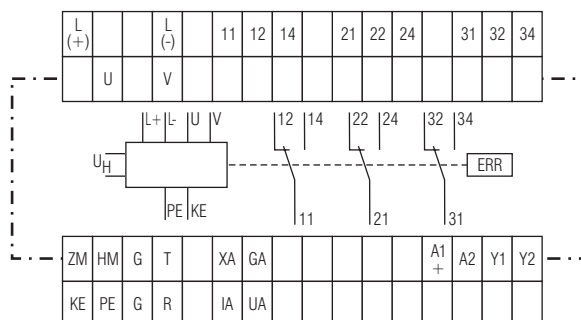

M10832_b

Function Diagram

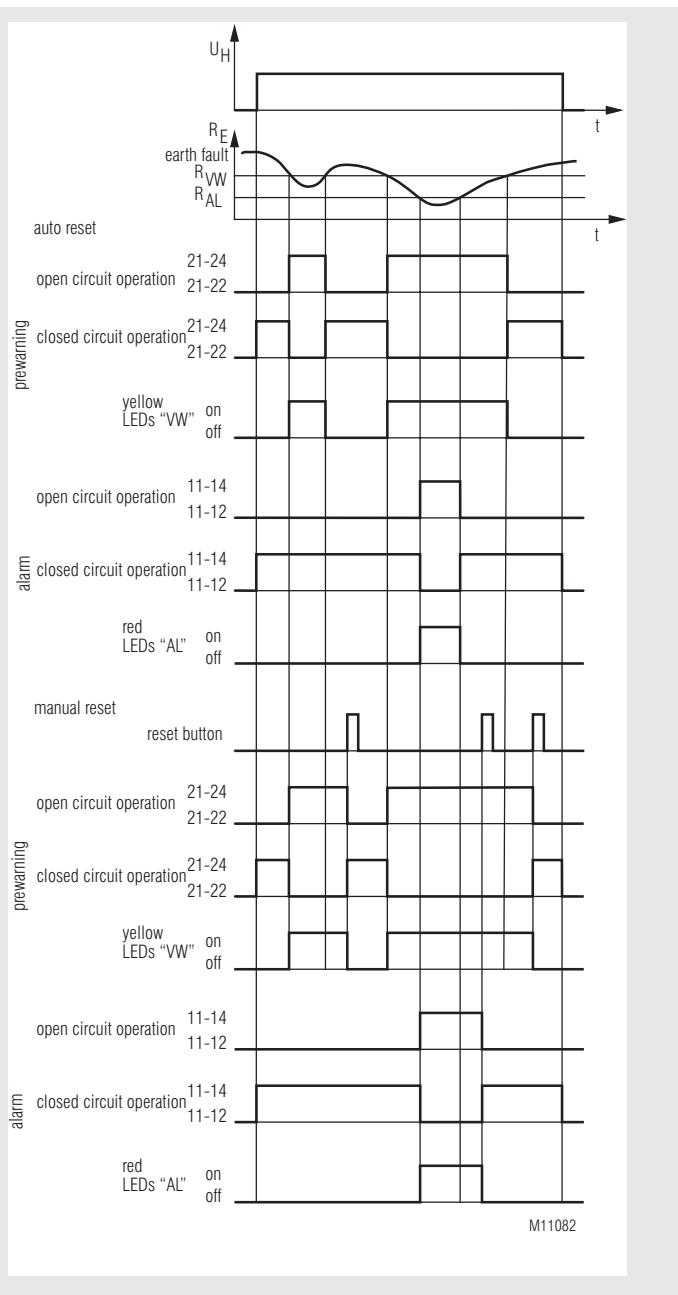

Function

The device is supplied with DC auxiliary voltage via terminals A1+ / A2; a green "PWR" LED comes on. Switching on the auxiliary voltage is followed by an internal self-test for 10 sec, where the LEDs of the indicator string light up in sequence. After this, measurement of the insulation resistance in the measuring circuits begins.

Main measuring circuit

(Insulation measurement between terminals L(+) / L(-) and PE / KE)

Terminals L(+) and L(-) are connected to the mains to be monitored. Broken wire detection, constantly effective during operation, generates an error message if both terminals are not connected with low resistance through the mains.

In addition, the two terminals PE and KE must be connected to the protective conductor system via separate lines. An error message is given here as well if a line is interrupted (see section "Actions in case of connection faults").

If the main measuring circuit is activated (terminal HM open), an active measuring voltage with alternating polarity is applied between L(+) / L(-) and PE / KE to measure the insulation resistance. During the measuring phase with positive polarity, the "HM" LED flashes with a long On-phase and with negative polarity with a short On-phase.

The "HM" LEDs goes off when the main measuring circuit is switched off through bridges of terminals HM-G. Measurement is suspended and no more measuring voltage reaches the measuring circuit, so that in case of coupling to a network where another insulation monitor is already active, no interference can occur.

The length of the positive and negative measuring phases depends on the settings on the rotary switch "CE/ μ F", the actual leakage capacitance of the monitored network and with DC networks, on the level and duration of possible mains voltage fluctuations. Correct and preferably quick measurement is thus given with different mains conditions. In the event of particularly adverse conditions and major interferences, the measuring analysis can be steadied and delayed in addition with rotary switch "tv" if necessary.

The current insulation resistance is determined and analysed at the end of each measuring phase. The LED-chain and the analogue output show the resistance determined, and the output relays for prewarning "VW" and alarm "AL" switch according to the respective response values set. If the response thresholds have been undercut, the LEDs "VW" or "AL" light according to the insulation fault location: "+", "-" or "+" and "-" simultaneously for AC faults or symmetric insulation faults.

Auxiliary measuring circuit

(Insulation measurement between terminals U / V and PE / KE)

The main measuring circuit is connected at the DC side for photovoltaic systems and hybrid vehicles. The AC side is disconnected as long as the inverter is switched off and can therefore not be monitored by the main measuring circuit for insulation faults. However, it is useful to monitor the AC side already before activating the inverter for insulation faults to PE for the inverter not to be even activated in the output circuit in case of insulation faults. For this reason, the insulation monitor LK5896 is equipped with an auxiliary measuring circuit determining the insulation resistance of the AC side to PE / KE. To this end, terminals U and V are connected to any phase preferred on the AC side. Broken wire detection is effective here as well and generates an error message if terminals U / V are not connected at low resistance, e.g. via load resistors, transformer or motor windings. The auxiliary measuring circuit is activated by bridging the device terminals ZM-G, for example, by the break contact of the (released) contactor that activates the inverter. The "ZM" LED lights when the auxiliary measuring circuit is activated.

The auxiliary measuring circuit monitors for the same response values as the main measuring circuit. The current insulation resistance in the auxiliary measuring circuit does not affect the analogue output but is displayed at values < approx. 1.7 M Ω on the LED-chain through corresponding LEDs, which are selected here in flashing function to distinguish from the main measuring circuit. The "ZM" LED flashes here at the same clock frequency. The LEDs of "VW" or "AL" flash if the respectively set response value is undercut only in the auxiliary measuring circuit.

Flashing Codes LED "ERR"

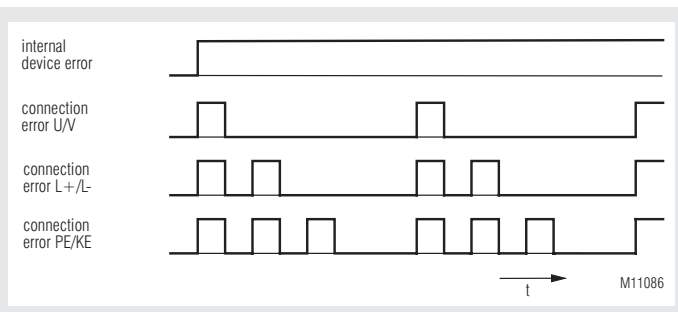

Function

Storing insulation fault message

If terminal R is open, the insulation fault messages from the main and auxiliary measuring circuit are stored when the respective response value is undercut, but also when the insulation resistance returns to the OK-range. In addition, the temporary minimum values of the insulation resistance are indicated on the LED-chain through dimmed LEDs.

If the "Reset" button on the device front is pressed or terminal R is connected with G, the stored insulation fault messages are reset when the insulation resistance is again in the OK-range.

Output relay for insulation fault messages

The rotary switch "CE/ μ F Rel." allows selecting the operating current (A) or standby current (R) principle for the output relays "AL" (contacts 11-12-14) and "VW" (contacts 21-22-24).

With the operating current principle, the relays respond when the response values are undercut, with the standby current principle they release when the response values are undercut.

If 2 different response values are not needed, "VW" and "AL" can be set to the same value. The output relays switch together in this case.

Analogue output

The LK 5896 features a universal analogue output to display the current insulation resistance in the main measuring circuit: Terminal UA-GA: 0 ... 10 V and terminal IA-GA: 0 ... 20 mA. By bridging terminals XA-GA, the output can be switched to 2 ... 10 V and 4 ... 20 mA.

Trigger output for insulation fault locating system

This trigger output (Y1-Y2) can be coupled with the trigger input Y1-Y2 of RR 5886 to initiate automatic fault location with the insulation fault locating system, consisting of RR 5886 and RR 5887. The trigger output is activated when the measuring value drops under the Alarm response value (AL). As long as it stays under the response value or an alarm is stored, the trigger output Y1-Y2 remains active. To prevent insulation monitor LK 5896 from affecting insulation fault locating, RR 5886 generates the deactivation signal for LK 5896 at its terminals H-G. It is applied to terminals HM-G of LK 5896 and deactivates its measuring circuit.

Broken wire detection

As mentioned above, both the main measuring circuit and the auxiliary measuring circuit are constantly monitored for wire breaks – not only at Power-On or a manual or occasional automatic test. The response time of monitoring is only a few seconds. Broken wire detection between L(+) and L(-) is performed via coupled alternating voltage. This alternating voltage is short-circuited if the terminals are connected to the connected mains at low-resistance. The device detects that the mains to be monitored is properly connected.

Since this broken wire detection is carried out with alternating voltage, large capacitances should be avoided between L(+) and L(-), since the capacitive reactance of these capacitances also short-circuits this alternating voltage. The device would no longer detect a connection fault on L(+)/L(-).

Especially parallel lines should be prevented over larger distances.

If larger capacitances between L(+)/L(-) cannot be avoided or if the coupled alternating voltage interferes with the system, version LK 5896.13/101 (without broken wire detection on L(+)/L(-)) shall be used.

Device test functions

Principally, 2 different test functions are implemented: The "self-test" and the "expanded test":

The self-test of the device is performed automatically after Power-On and every 4 operating hours. It can also be triggered manually at any time by pressing the "Test" button at the device front or with an external pushbutton connected between terminals T and G.

With the self-test, contrary to the expanded test, the status of the output relays and the analogue output are not affected; the sequence is as follows:

Switching to the negative measuring phase is performed for 4 sec. The "HM" LED flashes here with a brief On-phase. The LEDs of the LED-chain are selected in sequence and the internal circuit is checked. After this, switching to the positive measuring phase is performed for 4 sec. The "HM" LED flashes here with a long On-phase. The LED-chain cycles again and additional internal tests are performed. Insulation measurement continues normally after a pause of 2 sec if no faults have occurred.

Function

The expanded test is started when the internal or external "Test" button is pressed (or is still held) at the end of the 8 sec self-test, described above. The sequence is the same as with the self-test (2 measuring phases at 4 sec + 2 sec pause); however, the output relays "AL" and "VW" as well as the associated LEDs switch to the alarm state and the analogue output proceeds to its lowest value.

If the Reset button is pressed during the 8 sec or terminals R-G are connected, the expanded test is terminated after these 8 sec. Otherwise, the phases of the expanded test are constantly repeated, where, in addition, the "ERR" LED and the fault signalling relay (contacts 31-32-34) constantly receive current. However, the expanded test is terminated as soon as the Reset button is pressed. The device switches to the OK-state and restarts insulation measurement.

Behaviour with internal device faults

If internal device faults were detected during the test function, the "ERR" LED is lit continuously and the fault signalling relay (31-32-34) responds. The main measuring circuit is deactivated internally ("HM" LED goes off). The output relays "AL" and "VW" as well as the associated LEDs switch to the alarm state. The analogue output proceeds to its lowest value and all LEDs of the LED-chain extinguish.

Behaviour with connection faults

If the auxiliary measuring circuit is activated by bridging terminals ZM-G, broken wire detection in the auxiliary measuring circuit at U / V is signalled by the "ERR" LED flashing with "Error code 1" and the fault signalling relay responds. Measurement and analysis for the main measuring circuit continue normally.

Measurement is suspended if a line interruption is detected at terminals L(+) / L(-); the "HM" LED goes off. The state of the output relays "AL" / "VW" and associated LEDs, the display of the LED-chain and the analogue output are "frozen". This Broken wire detection is signalled by the "ERR" LED flashing with "Error code 2" and the fault signalling relay responds. Measurement of the connection insulation resistance restarts after the connection interruption has been corrected. However, stored alarm messages are preserved. If the connections PE / KE to the protective-conductor system are interrupted, the same responses take place as with an interruption at terminals L(+) / L(-), only that the "ERR" LED indicates "Error code 3".

Indicators	
Green LED „PWR“:	On when auxiliary supply connected
Red LED „ERR“:	Permanent on: At system error Flashing: At connection failure
Green LED „HM“:	Flashing: At active main measuring circuit, ON-OFF-ratio per measurement phase: Long ON period during measurement phase with positiv polarity Short ON period during measurement phase with negative polarity
Green LED „ZM“:	Permanent on: At active auxiliary measuring circuit, Flashing: At $RE < 2 M\Omega$
Yellow LED-chain:	8 LEDs indicate the actual insulating resistance ($\leq 10 k\Omega \dots \geq 2 M\Omega$) Flashing: For auxiliary measuring circuit
Yellow LED „VW +“:	Permanent on: RE lower then prewarning value to + potential Flashing: For auxiliary measuring circuit
Yellow LED „VW -“:	Permanent on: RE lower then prewarning value to - potential Flashing: For auxiliary measuring circuit
Yellow LEDs „VW +“ and „VW -“ simultaneity:	Permanent on: AC-fault / symmetric fault Flashing: For auxiliary measuring circuit
Red LED „AL +“:	Permanent on: RE lower then tripping value to + potential Flashing: For auxiliary measuring circuit
Red LED „AL -“:	Permanent on: RE lower then tripping value to - potential Flashing: For auxiliary measuring circuit
Red LEDs „AL +“ and „AL -“ simultaneity:	Permanent on: AC-fault / symmetric fault Flashing: For auxiliary measuring circuit

Notes



Risk of electrocution! Danger to life or risk of serious injuries.

- Disconnect the system and device from the power supply and ensure they remain disconnected during electrical installation.
- The voltage of the monitored voltage system is connected to terminals L(+) / L(-). Please observe sufficient distance to terminals of neighbour devices and to the grounded metal cabinet or box (min 0.5 cm).
- The terminals of the control inputs ZM, HM, T, R and G have no galvanic separation to the measuring circuit L(+) and L(-) and are electrically connected together, therefore they have to be controlled by volt free contacts or bridge. These contacts ore bridges must provide a sufficient separation depending on the mains voltage on L(+)-L(-).
- No external potentials may be connected to control terminals ZM, HM, T and R. The associated reference potential is G (identical with PE), and the connection of the terminals is made via bridges to G.



Attention!

- Before checking insulation and voltage, disconnect the monitoring device LK 5896 from the power source!
- Only one insulation monitor may be active in a network to be monitored, since the devices would otherwise influence each other. When coupling several networks or incoming feed sections, where each of them is equipped with its own insulation monitor, all of them must be deactivated except for one insulation monitor. Such deactivation can be beneficially handled via the HM-G control terminals with the LK 5896.
- Device terminals PE and KE must always be connected via separate lines to different terminal points of the protective-conductor system.
- The device must not be operated without KE/PE connection!
- The measuring circuit should not be connected via longer parallel guided wires, as this may interfere with the broken wire detection. Also large capacities between L(+) und L(-) have to be avoided.



Attention!

- The main measuring circuit can be connected with its terminals L(+) and L(-) both to the DC and also AC side of a mixed network; it is done most practically where the primary incoming power supply takes place. Selector switch "tv / U_N" should be set accordingly. For photovoltaic systems and hybrid vehicles, the main measuring circuit of the LK 5896 is connected on the DC side; the auxiliary measuring circuit can then be used to monitor the (deactivated) AC side.
- If a monitored AC system includes galvanically connected DC circuits (e.g. via a rectifier), an insulation failure on the DC side can only be detected correctly, when a current of min 10 mA can flow via the semi-conductor connections.
- If a monitored DC system includes galvanically connected AC circuits (e.g. via an inverter), an insulation failure on the AC side can only be detected correctly, when a current of min 10 mA can flow via the semi-conductor connections.
- The main measuring circuit is designed for large leakage capacitances up to 3000 μF . The selection switch "CE/ μF " must be set accordingly. Measurement of the insulation resistances is not falsified by this; however, longer periods are required for the measuring phases than with small capacitances. If the maximum approximate leakage capacitance is known, the selector switch "CE/ μF " can possibly be set to smaller values, which reduces the response time further.
- The analogue output and trigger output Y1-Y2 are electrically separated from the rest of the circuitry. The trigger output is intended for connection to the DOLD insulation fault locator system, consisting of RR 5886 and RR 5887. No external voltages may be applied.
- For the main measuring circuit, the nominal voltage range for DC is specified with 1000 V; however, absolute values up to max. DC 1500 V are permissible.

Technical Data

Main measuring circuit L(+) / L(-) to PE / KE

Nominal voltage U_N :	DC 0 ... 1000 V; AC 0 ... 1000 V
Voltage range:	DC max. 1500 V; AC max. 1100 V
Frequency range:	DC or 16 ... 1000 Hz
Max. line capacitance:	3000 μ F
Internal resistance (AC / DC):	> 280 k Ω
Measuring voltage:	Approx. \pm 95 V
Max. measured current ($R_E = 0$):	< 0.35 mA

Auxiliary measuring circuit U / V to PE / KE

Nominal voltage U_N :	AC 0 ... 690 V
Voltage range:	0 ... 1.1 U_N
Frequency range:	16 ... 1000 Hz
Max. line capacitance:	10 μ F
Internal resistance (AC / DC):	Approx. 2 M Ω
Measuring voltage:	Approx. 12 V
Max. measured current ($R_E = 0$):	Approx. 6 μ A

Response values R_E

Pre-warning („VW“):

k Ω :	20	30	50	70	100	150	250	500	1000	2000
--------------	----	----	----	----	-----	-----	-----	-----	------	------

Alarm („AL“)

k Ω :	1	2	10	20	30	50	70	100	150	250
--------------	---	---	----	----	----	----	----	-----	-----	-----

Each adjustable via rotational switches

Response inaccuracy:	\pm 15 % + 1.5 k Ω	IEC 61557-8
Response value hysteresis		
At range 10 k Ω ... 700 k Ω :	Approx. 25 %	
Out of range:	Approx. 40 % + 0.5 k Ω	
On delay		
At $C_E = 1 \mu$ F,		
R_E of ∞ to 0.5 * response value:	< 10 s	
Measuring time:	See characteristics	

Input auxiliary voltage

DC-Input (A1+ / A2)

Nominal voltage U_H :	DC 24 V
Voltage range:	0.8 ... 1.25 U_H
Nominal consumption:	Max. 5 W

Control input (between ZM, HM, T, R and G)

Current flow:	Approx. 3 mA
No-load voltage to G:	Approx. 12 V
Permissible wire length:	< 50 m
Min. activation time:	0.5 s

Output

Contacts:	3 x 1 changeover contacts for VW, AL and ERR
Thermal current I_{th} :	4 A
Switching capacity	
To AC 15:	
NO contact:	3 A / AC 230 V IEC/EN 60947-5-1
NC contact:	1 A / AC 230 V IEC/EN 60947-5-1
Electrical life	
At 8 A, AC 250 V:	1 x 10 ⁴ switching cycles
Short circuit strength	
max. fuse rating:	4 A gG / gL IEC/EN 60947-5-1
Mechanical life:	10 x 10 ⁶ switching cycles

Analogue output

For actual insulating value, with standard-output function galvanic separation

Terminals IA(+)/ GA:	0 ... 20 mA (bridge XA-GA: 4 ... 20 mA); max. burden 500 Ω
Terminals UA(+)/ GA:	0 ... 10 V (bridge XA-GA: 2 ... 10 V); max. current 10 mA

Scaling

Lower analogue value:	$R_E = 0$;
Upper analogue value:	$R_E = \infty$
Middle of range:	$R_E = 289 \text{ k}\Omega$

Formula example

For 0 ... 10 V:	$R_E = 289 \text{ k}\Omega / (10V / UA - 1)$
For 2 ... 10 V:	$R_E = 289 \text{ k}\Omega / (8V / (UA-2V) - 1)$

Technical Data

General Data

Operating mode:	Continuous operation
Temperature range	
Operation:	- 25 ... + 60 °C (device mounted away from heat generation components)
	- 25 ... + 45 °C (device mounted without distance heated by devices with same load)

Storage:	- 40 ... + 70 °C
Relative air humidity:	93 % bei 40 °C
Atmospheric pressure:	860 ... 1600 mbar (86 ... 106 kPa)
Altitude:	\leq 4000 m IEC 60664-1

Clearance and creepage distances

Rated impulse voltage / pollution degree	IEC 60664-1
--	-------------

Main measuring circuit L(+) / L(-) to auxiliary voltage DC and relay contacts VW, AL, ERR and analogue output IA, UA, GA and trigger output Y1-Y2: 8 kV / 2

Auxiliary measuring circuit U / V to auxiliary voltage DC and relay contacts VW, AL, ERR and analogue output IA, UA, GA and trigger output Y1-Y2: 8 kV / 2

Auxiliary voltage DC and trigger output Y1-Y2 to relay contacts VW, AL, ERR and analogue output IA, UA, GA: 8 kV / 2

Relay contact VW to relay contact AL to relay contact ERR: 4 kV / 2

Analogue output IA, UA, GA to relay contacts VW, AL, ERR and trigger output Y1-Y2: 4 kV / 2

Trigger output Y1-Y2 to relay contacts VW, AL, ERR: 4 kV / 2

Insulation test voltage

Routine test: AC 5 kV; 1 s
AC 2.5 kV; 1 s

EMC

Electrostatic discharge (ESD): 8 kV (air) IEC/EN 61000-4-2

HF irradiation: 80 MHz ... 2.7 GHz: 10 V / m IEC/EN 61000-4-3

Fast transients: 4 kV IEC/EN 61000-4-4

Surge voltages

Between A1 - A2: 1 kV IEC/EN 61000-4-5

Between L(+) - L(-): 2 kV IEC/EN 61000-4-5

Between A1, A2 - PE and L(+), L(-) - PE: 4 kV IEC/EN 61000-4-5

Between control line: 0,5 kV IEC/EN 61000-4-5

Between control line and earth: 1 kV IEC/EN 61000-4-5

HF-wire guided: 10 V IEC/EN 61000-4-6

Interference suppression: Limit value class A*)

*) The device is designed for the usage under industrial conditions (Class A, EN 55011).

When connected to a low voltage public system (Class B, EN 55011) radio interference can be generated. To avoid this, appropriate measures have to be taken.

Degree of protection

Housing: IP 40 IEC/EN 60529

Terminals: IP 20 IEC/EN 60529

Housing: Thermoplastic with V0 behaviour according to UL subject 94

Vibration resistance: IEC/EN 60068-2-6

Amplitude 0.35 mm frequency 10 ... 55 Hz

Amplitude \pm 1 mm, frequency 2 ... 13.2 Hz

13.2 ... 100 Hz, acceleration \pm 0.7 g_r

10 g_r / 11 ms, 3 pulses IEC/EN 60068-2-27

25 / 060 / 04 IEC/EN 60068-1

Shock resistance: EN 50005

Climate resistance:

Terminal designation:

Technical Data	
Wire connection	DIN 46228-1/-2/-3/-4
Screw terminals (fixed):	1 x 4 mm ² solid or 1 x 2.5 mm ² stranded ferruled (isolated) or 2 x 1.5 mm ² stranded ferruled (isolated) DIN 46228-1/-2/-3-4 or 2 x 2.5 mm ² stranded ferruled (isolated) DIN 46228-1/-2/-3
Insulation of wires or sleeve length:	8 mm
Wire fixing:	Plus-minus terminal screws M3,5 terminal with wire protection
Fixing torque:	0.8 Nm
Mounting:	DIN rail IEC/EN 60715
Weight:	Approx. 584 g
Dimensions	
Width x height x depth:	90 x 90 x 121 mm

UL-Data

Main measuring circuit L(+) / L(-) to PE / KE

Voltage range: AC/DC max. 600 V

Auxiliary measuring circuit U / V to PE / KE

Voltage range: AC max. 600 V

Switching capacity: Pilot duty B300, C300, R300
4 A 250 Vac, Resistive
4 A 30 Vdc, Resistive

Wire connection: Min. 60°C copper conductors only
Torque 0.8 Nm

Test specification: ANSI/UL 60947-1, 5th Edition
ANSI/UL 60947-5-1, 3rd Edition
CAN/CSA-C22.2 No. 6047-1-13, 2nd Edition
CAN/CSA-C22.2 No. 60947-5-1-14, 1st Edition



Technical data that is not stated in the UL-Data, can be found in the technical data section.

Standard Type

LK 5896.13/100 DC 24 V	
Article number:	0065131
• Outputs:	1 changeover contact for pre-warning 1 changeover contact for alarm 1 changeover contact for connection- / system error
• Auxiliary measuring circuit for inverter output	
• Auxiliary voltage:	DC 24 V
• Setting range pre-warning:	20 kΩ ... 2 MΩ
• Setting range alarm:	1 kΩ ... 250 kΩ
• Adjustable line capacitance	
• Open- / or closed circuit operation	
• Adjustable time delay / selection of AC or DC connection	
• Analogue output:	0 ... 20 mA / 4 ... 20 mA; 0 ... 10 V / 2 ... 10 V
• Trigger output for insulation fault locating system	
• Width:	90 mm

Variant

LK 5896.13/101:	Without wire-break detection at L(+)/L(-)
LK 5896.13/800:	Analogue output with linear output function to indicate the actual insulation resistance value Scaling: Lower analogue value: $R_E = 0$ Upper analogue value: $R_E = 100 \text{ k}\Omega$ Middle of range: $R_E = 50 \text{ k}\Omega$ Output function see characteristics
LK 5896.13/801:	With adapted measurement algorithm for PV plants and galvanically separated analogue output with linear output function to indicate the actual insulation resistance value. Scaling: Lower analogue value: $R_E = 0$ Upper analogue value: $R_E = 100 \text{ k}\Omega$ Middle of range: $R_E = 50 \text{ k}\Omega$ Output function see characteristics

Ordering Example for Variants

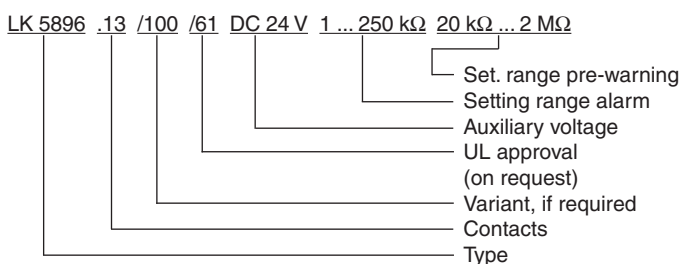

Accessories

EH 5861/005:

Indicating instrument,
degree of protection: IP 52
Article number: 0067516



The indicating device EH 5861 is externally connected to the insulation monitor on terminals UA / GA (0 - 10 V) and shows the actual insulation resistance of the voltage system to ground.

Dimensions:
Width x height x depth
96 x 96 x 52 mm

Connection Examples

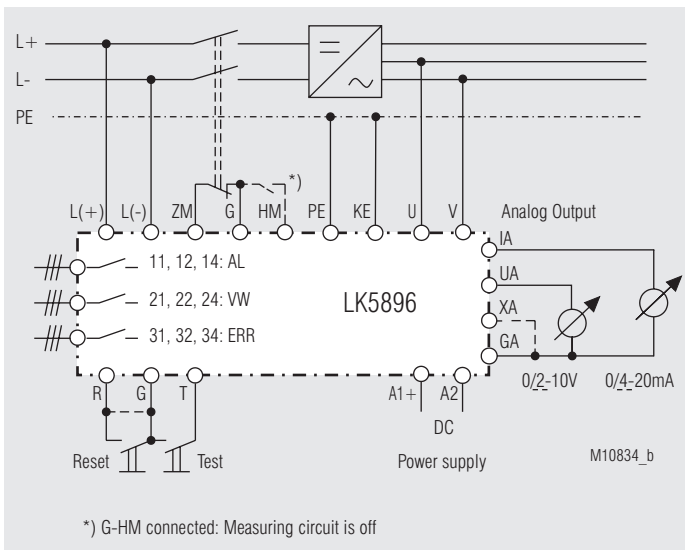

Insulation monitoring DC-side

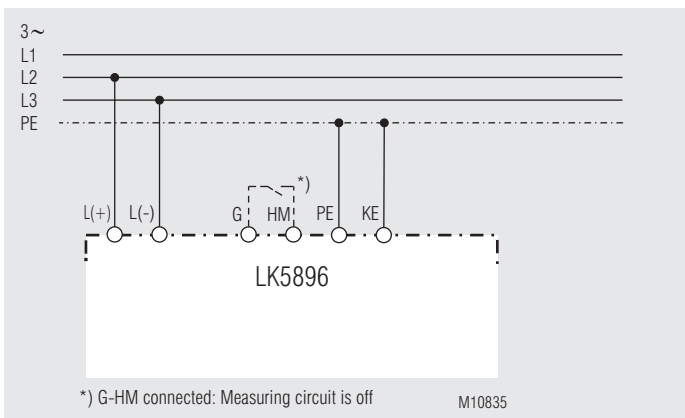

Insulation monitoring AC-side

Characteristic - Analogue Output with Standard-Output Function -

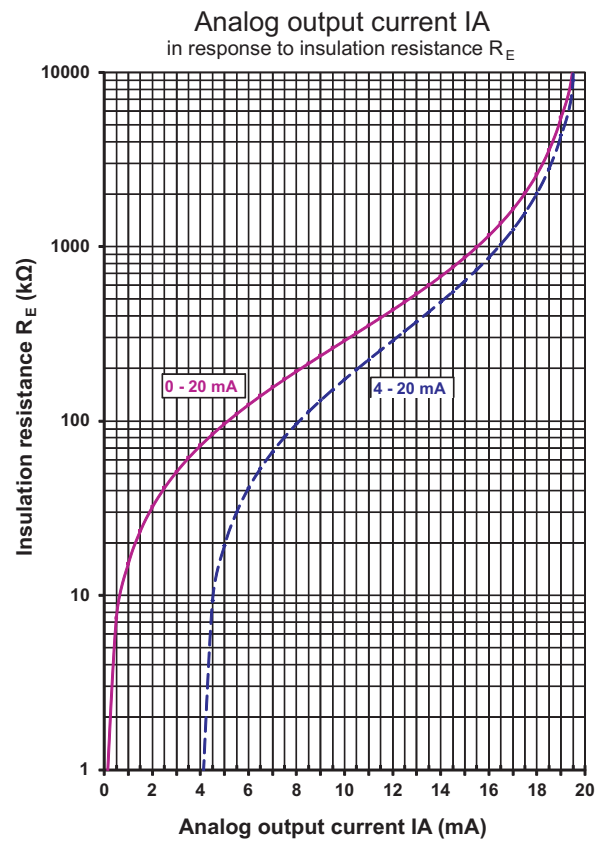
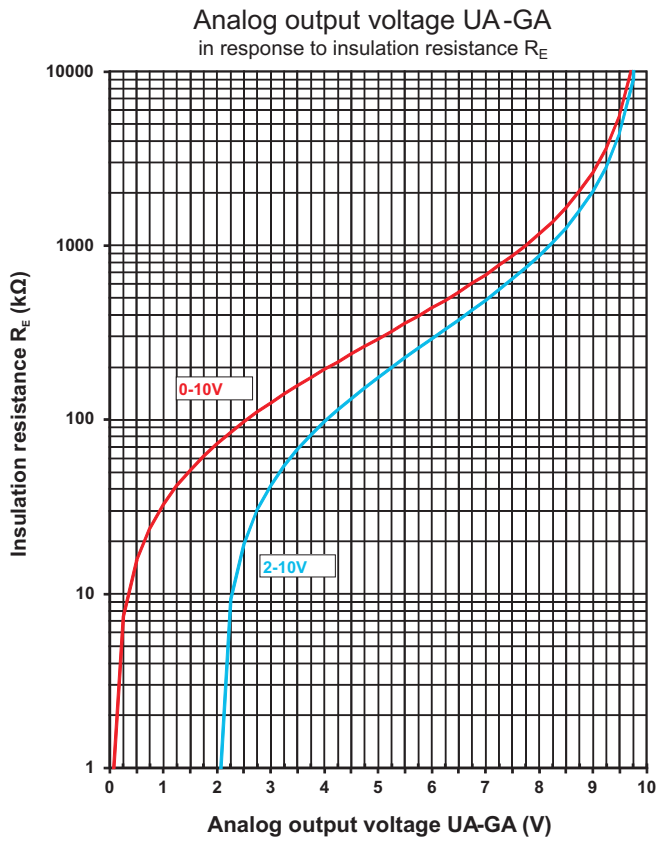

Characteristic - Analogue Output with Linear Output Function -

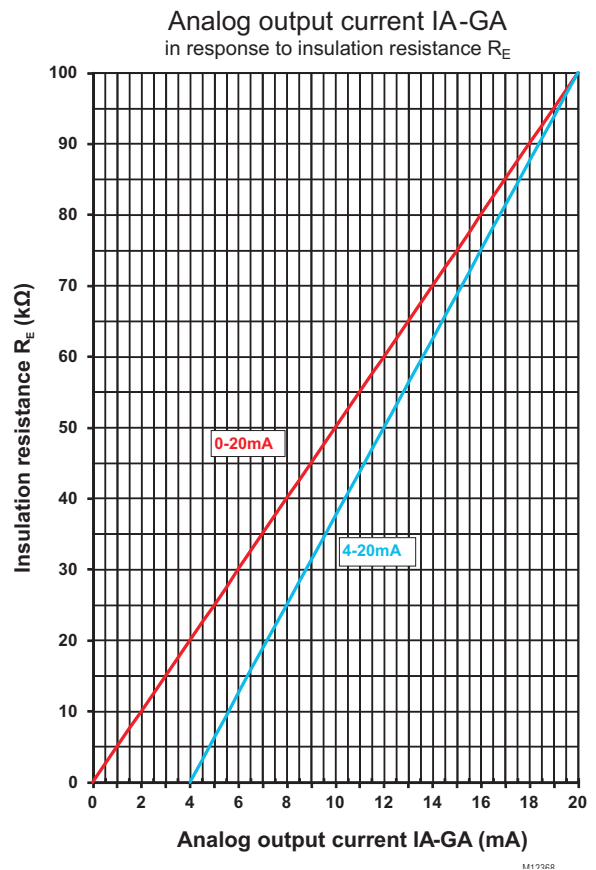
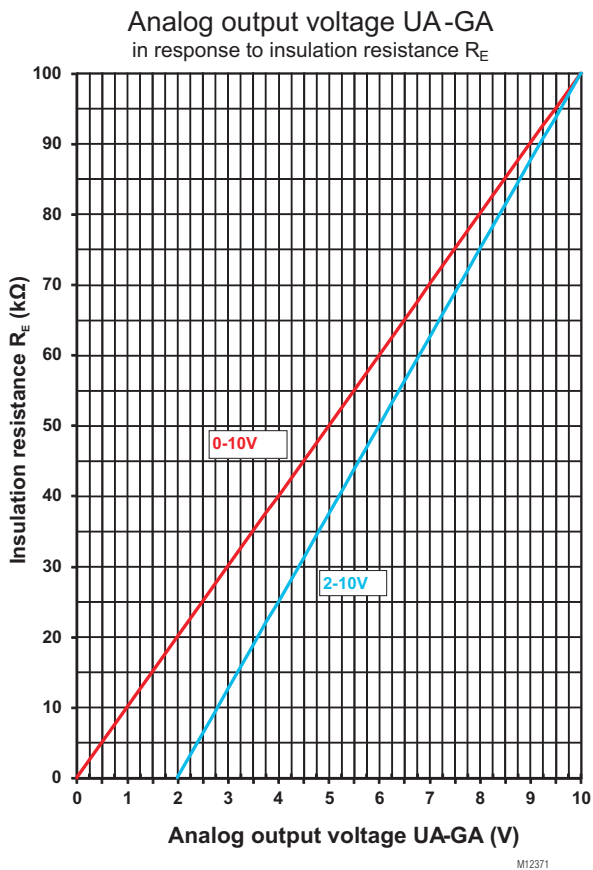

Max. measuring time in response to line capacitance

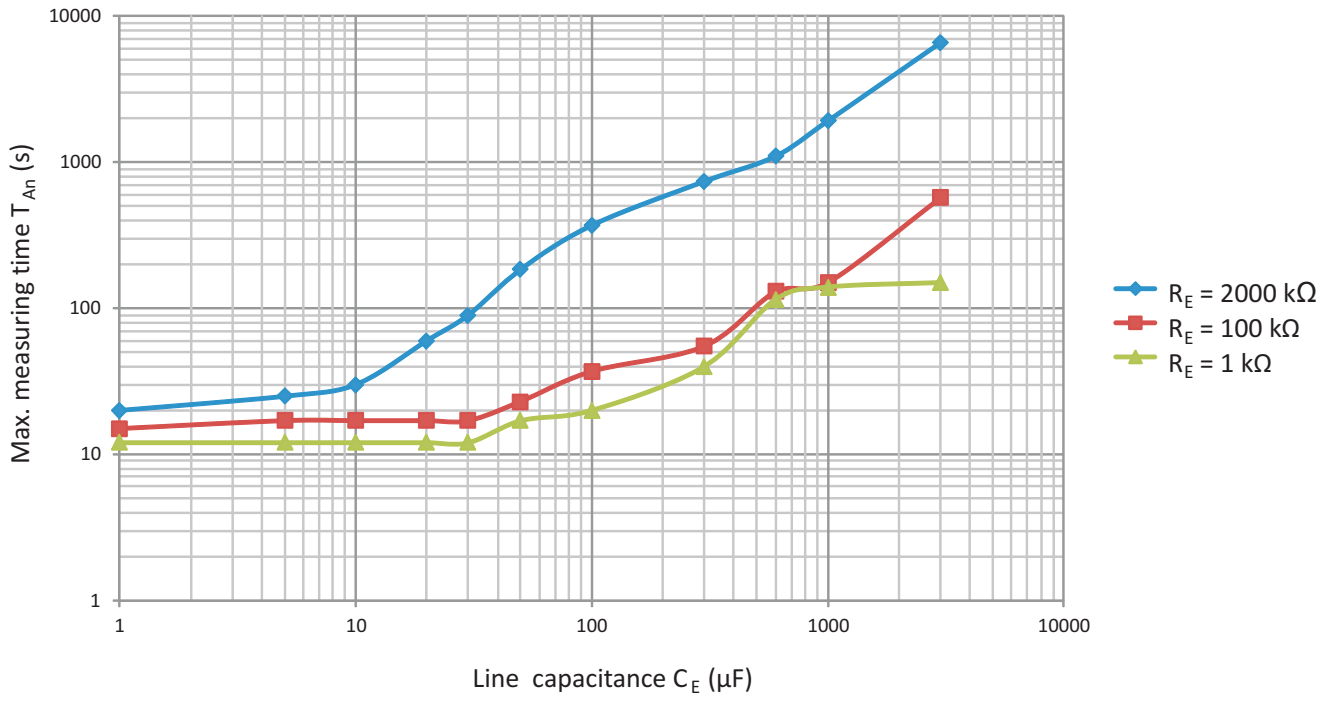

M11295

