



Ex position switch with safety function

Ex 13 FR 1Ö/1S - 2m

Material number: 1189148 (Material number old: 13051304)

Features/Options:

- Ex zone 1 and 21
- Thermoplastic enclosure
- Double insulated
- With pre-wired cable
- Actuator: Roller plunger for front mounting FR

- Actuating speed max. 0.5 m/s with a vertical actuating angle of 25°
- Metal roller
- Attention: Please state required international approvals with your order!

Notes

- Actuator can be repositioned by 90° on request

Dimensions

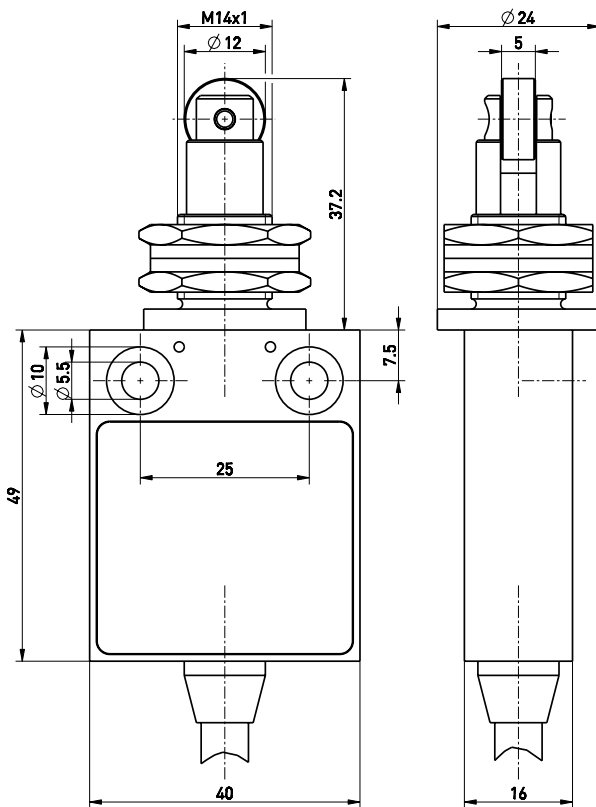

Technical data

Applied standards	EN 60947-5-1, EN 60079-0, EN 60079-1, EN 60079-31, EN ISO 13849-1, EN ISO 14119
Enclosure	thermoplastic, glass-fibre reinforced, impact resistant, self-extinguishing UL 94 V-0
Switch type	type 1
Coding level	no coding
Degree of protection	IP 65 (EN 60079-0 + IEC/EN 60529) IP 67 (IEC/EN 60529)
B _{10d} (10 % load)	2 million
T _M	max. 20 years
Contact material	silver
Switching system	slow action, positive break NC contacts \ominus
Switching elements	1 NC/1 NO contact, type Zb
Connection	pre-wired cable H05VV-F
Cable cross-section	4 x 0.75 mm ² (incl. conductor ferrules)
Cable length	2 m
Rated impulse withstand voltage U _{imp}	4 kV
Rated insulation voltage U _i	250 V
Conventional thermal current I _{the}	T6: 6 A, T5: 3 A
Rated operating current/voltage I _e /U _e	6 A/250 VAC; 0.25 A/230 VDC
Utilisation category	AC-15; DC-13

Errors and omissions excepted.



Ex position switch with safety function

Ex 13 FR 1Ö/1S - 2m

Material number: 1189148 (Material number old: 13051304)

Technical data

Short-circuit protection	6 A gG/gN fuse
Ambient temperature	T6: -20 °C ... +65 °C, T5: -20 °C ... +75 °C, +90 °C with max. 3 A
Mechanical life	> 1 million operations
Operation cycles	max. 1800/h
Repeat accuracy of switching points	± 0.1 mm
Contact opening	max. 2 x 4 mm
Impact energy	max. 7 J
Ex marking	⊕ II 2G Ex db IIC T6/T5 Gb, ⊕ II 2D Ex tb IIIC T80 °C/T95 °C Db IECEX Ex db IIC T6/T5 Gb, Ex tb IIIC T80 °C/T95 °C Db
Approvals	PTB 03 ATEX 1068 X IECEX PTB 06.0053X
Weight	110 g

Switching diagram

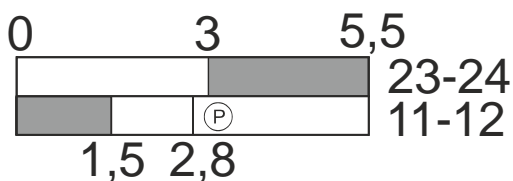

Ⓟ Positive break travel/angle

Contact diagram

