



## Magnetic sensor

RC 23 1W-1m

Material number: 1045853 (Material number old: 22330101)

### Features/Options:

- Metal enclosure
- Long life
- 1 Reed contact
- Actuation from front and from side
- Switching distance up to 30 mm depending on the actuating magnet
- With pre-wired cable

### Notes

- 2 mounting nuts are included in delivery
- The actuator is not included in the delivery of the switches

### Dimensions

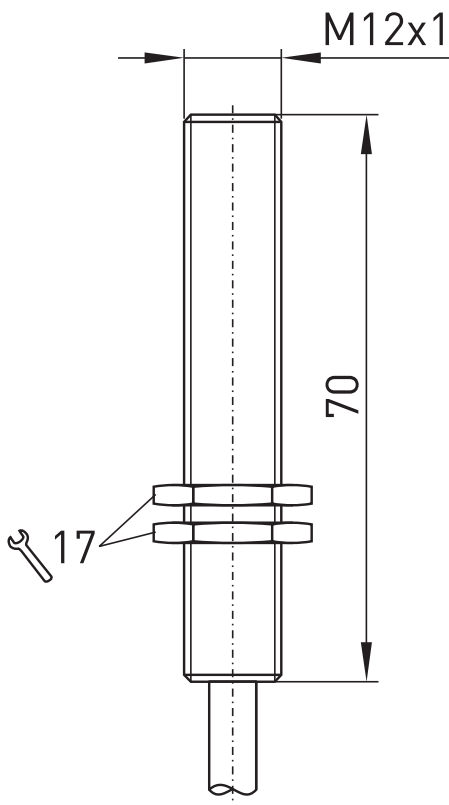

### Technical data

Applied standards	EN 60947-5-2
Enclosure	brass, nickel
Degree of protection	IP 67 to IEC/EN 60529
Switching system	reed contacts
Switching elements	1 change-over contact
Connection	pre-wired cable PVC
Cable cross-section	3 x 0.5 mm <sup>2</sup>
Cable length	1 m
Switching voltage	max. 250 VAC/DC
Switching current	max. 0.5 A
Switching capacity	max. 15 W
Switching frequency	max. 200 Hz
Ambient temperature	-10 °C ... +80 °C
Mechanical life	10 <sup>9</sup> operations
Repeatability	± 0.02 mm
Vibration resistance	10 g
Weight	80 g

Errors and omissions excepted.



Magnetic sensor

RC 23 1W-1m

Material number: 1045853 (Material number old: 22330101)

Contact diagram

