



Ex position switch with safety function

Ex 14 WKU 1Ö/1S - 2m

Material number: 1179897 (Material number old: 14004302)

Features/Options:

- Ex zone 1 and 21
- Thermoplastic enclosure
- Double insulated
- Mounting details to EN 50047
- Suitable for in-line mounting
- With pre-wired cable
- Actuator: Ball plunger with collar WKU
- Actuating speed max. 0.5 m/s with a vertical actuating angle of 20°
- Vertical actuation or actuation from side possible
- Actuator with captive stainless steel ball
- Exact repeatability of switching point
- Watertight collar for protection against penetration of dirt
- Attention: Please state required international approvals with your order!

Dimensions

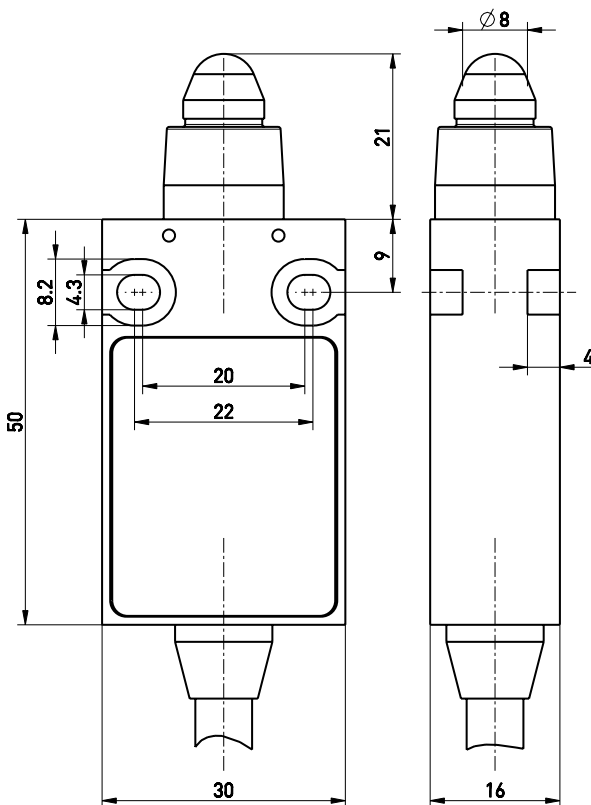

Technical data

Applied standards	EN 60947-5-1, EN 60079-0, EN 60079-1, EN 60079-31, EN ISO 13849-1, EN ISO 14119
Enclosure	thermoplastic, glass-fibre reinforced, impact resistant, self-extinguishing UL 94 V-0
Switch type	type 1
Coding level	no coding
Degree of protection	IP 65 to IEC/EN 60529
B _{10d} (10 % load)	2 million
T _M	max. 20 years
Contact material	silver
Switching system	slow action, positive break NC contacts \ominus
Switching elements	1 NC/1 NO contact, type Zb
Connection	pre-wired cable H05VV-F
Cable cross-section	4 x 0.75 mm ² (incl. conductor ferrules)
Cable length	2 m
Rated impulse withstand voltage U _{imp}	4 kV
Rated insulation voltage U _i	250 V
Conventional thermal current I _{the}	T6: 6 A, T5: 3 A
Rated operating current/voltage I _e /U _e	6 A/250 VAC; 0.25 A/230 VDC
Utilisation category	AC-15; DC-13
Short-circuit protection	6 A gG/gN fuse

Errors and omissions excepted.



Ex position switch with safety function

Ex 14 WKU 1Ö/1S - 2m

Material number: 1179897 (Material number old: 14004302)

Technical data

Ambient temperature	T6: -20 °C ... +65 °C, T5: -20 °C ... +75 °C, +90 °C with max. 3 A
---------------------	--

Mechanical life	> 1 million operations
-----------------	------------------------

Operation cycles	max. 1800/h
------------------	-------------

Repeat accuracy of switching points	± 0.1 mm
-------------------------------------	----------

Contact opening	max. 2 x 4 mm
-----------------	---------------

Ex marking	II 2G Ex db IIC T6/T5 Gb, II 2D Ex tb IIIC T80 °C/T95 °C Db IECEX Ex db IIC T6/T5 Gb, Ex tb IIIC T80 °C/T95 °C Db
------------	---

Approvals	PTB 03 ATEX 1070 X IECEX PTB 06.0098X
-----------	--



Weight	194 g
--------	-------

Contact diagram

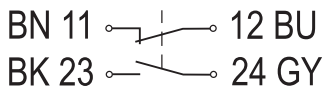

Switching diagram

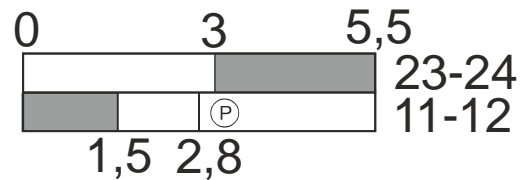

Ⓟ Positive break travel/angle