



Pull-wire switch ZS 71 2Ö / 55 N

Material number: 1048098 (Material number old: 71541001)

Features/Options:

- Metal enclosure
- 2 contacts
- Compact design
- Wire length up to 5 m
- Spring force variant: 55 N
- Wire pull and breakage detection
- Without mechanical latching

Notes

- At 3 m distance intermediate wire supports are required. One wire thimble is provided.

Dimensions

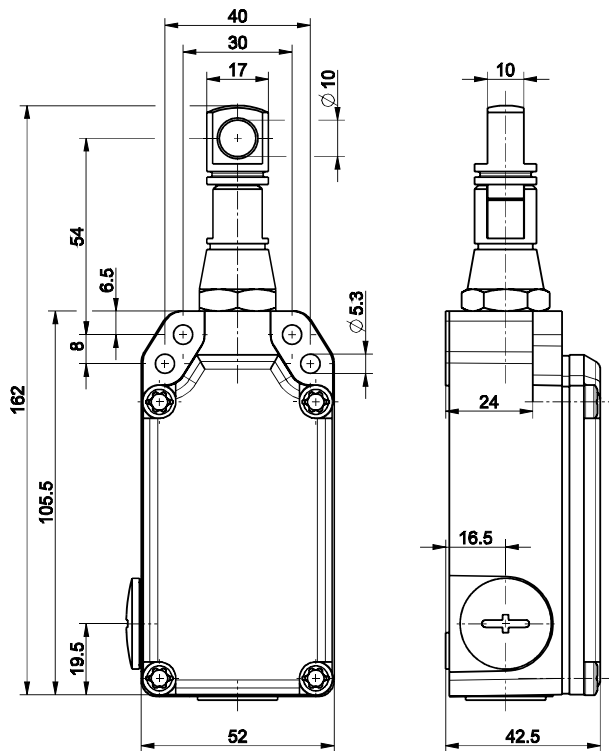

Technical data

Applied standards	EN 60947-5-1, EN ISO 13849-1, GS-ET-15
Enclosure	aluminium die-cast, powder-coated
Cover	thermoplastic, glass-fibre reinforced, impact resistant, self-extinguishing UL 94 V-0
Degree of protection	IP 65 to IEC/EN 60529
B_{10d} (10 % load)	2 million
T_M	max. 20 years
Contact material	silver
Switching system	snap action, positive break NC contacts \ominus
Switching elements	2 NC contacts
Connection	screw connection terminals
Cable cross-section	max. 2.5 mm ² (incl. conductor ferrules)
Cable entry	2 x M20 x 1.5
Rated impulse withstand voltage U_{imp}	6 kV
Rated insulation voltage U_i	400 V
Conventional thermal current I_{the}	6 A
Utilisation category	AC-15
Rated operating current/voltage I_e/U_e	6 A/400 VAC
Short-circuit protection	6 A gG/gN fuse
Ambient temperature	-25 °C ... +70 °C
Mechanical life	> 1 million operations

Errors and omissions excepted.



Pull-wire switch ZS 71 2Ö / 55 N

Material number: 1048098 (Material number old: 71541001)

Technical data

Max. wire length 5 m

Approvals

Weight 380 g

Switching diagram

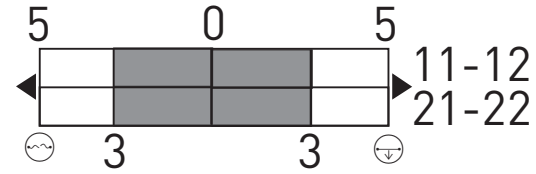

- Wire breakage detection
- Wire pull detection

Contact diagram

