



Miniature limit switch

C 50 R 1Ö/1S

Material number: 1046962 (Material number old: 49009001)

Features/Options:

- Thermoplastic enclosure

- Actuator: Roller plunger R

Notes

- With roller plunger turned 90° available on request

Dimensions

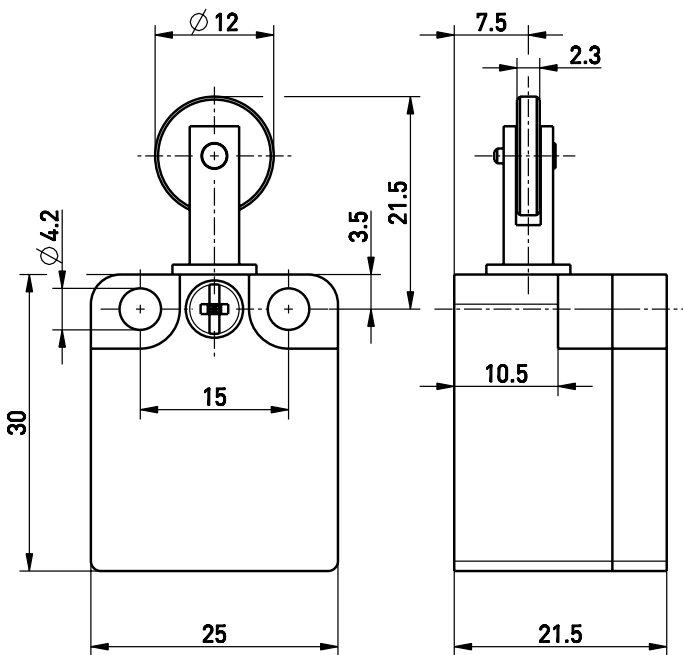

Technical data

Applied standards	EN ISO 13849-1, EN 60947-5-1
Enclosure	thermoplastic, glass-fibre reinforced, impact resistant, self-extinguishing UL 94 V-0
Actuator	plunger: brass
Tightening torque	enclosure mounting screws: approx. 1 Nm cover screws: approx. 0.6 Nm
Degree of protection	IP 30 to IEC/EN 60529
B_{10d} (10 % load)	500 000
T_M	max. 20 years
Degree of pollution	3
Contact material	silver
Switching system	slow action, positive break NC contacts \ominus
Switching elements	1 NC/1 NO contact, type Zb
Connection	screw connection terminals
Cable cross-section	max. 1.5 mm ²
Rated impulse withstand voltage U_{imp}	4 kV
Rated insulation voltage U_i	400 V
Conventional thermal current I_{the}	4 A
Rated operating current/voltage I_e/U_e	4 A/400 VAC
Utilisation category	AC-15
Short-circuit protection	4 A gG/gN fuse
Ambient temperature	-20 °C ... +75 °C
Mechanical life	> 1 million operations
Operation cycles	max. 1800/h

Errors and omissions excepted.



Miniature limit switch

C 50 R 1Ö/1S

Material number: 1046962 (Material number old: 49009001)

Technical data

Repeat accuracy of switching points ± 0.1 mm

Contact opening max. 2 x 4 mm

Approvals



Weight

22 g

Contact diagram

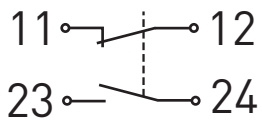

Switching diagram

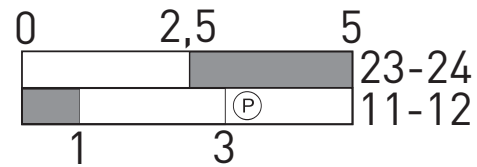

Ⓟ Positive break travel/angle