



Position switch

E 12 DD - 2m

Material number: 1188887 (Material number old: 12725005)

Features/Options:

- Metal enclosure
- Snap action, change-over contact with single break
- Suitable for in-line mounting
- With pre-wired cable

Notes

- Actuator can be repositioned by 180° on request

Dimensions

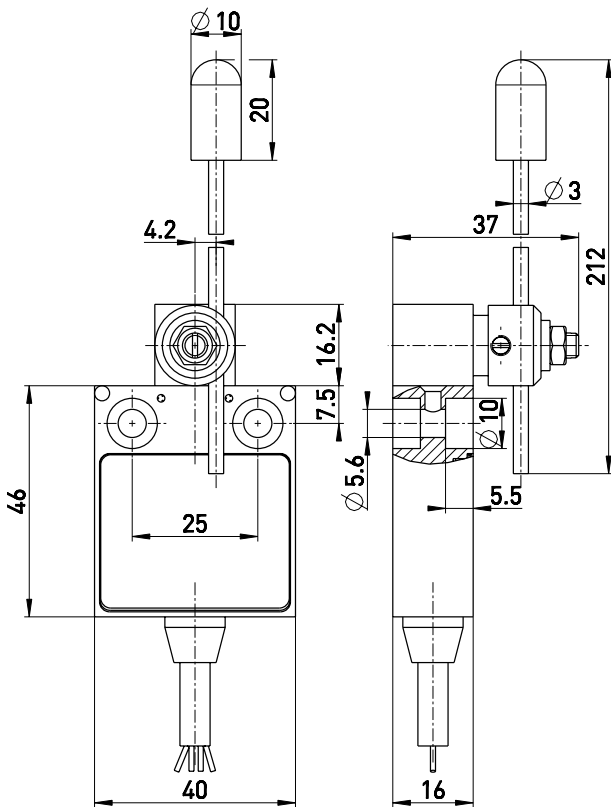

Technical data

Applied standards	EN 60947-5-1
Enclosure	aluminium die-cast, powder-coated
Degree of protection	IP 67 to IEC/EN 60529
Contact material	silver
Switching elements	1 change-over contact with single break, type C
Switching system	snap action
Connection	pre-wired cable H05VV-F
Cable cross-section	4 x 0.75 mm ²
Cable length	2 m
Rated impulse withstand voltage U_{imp}	4 kV
Rated insulation voltage U_i	250 V
Conventional thermal current I_{the}	5 A
Utilisation category	AC-15; DC-13
Rated operating current/voltage I_e/U_e	5 A/250 VAC; 0.16 A/230 VDC
Short-circuit protection	5 A gG/gN fuse
Mechanical life	> 1 million operations
Operation cycles	max. 1800/h
Ambient temperature	-20 °C ... +75 °C

Approvals



Errors and omissions excepted.



Position switch

E 12 DD - 2m

Material number: 1188887 (Material number old: 12725005)

Switching diagram

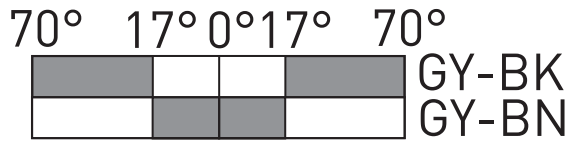

Contact diagram

