



Position switch with safety function

ES 41 R 2Ö

Material number: 1046525 (Material number old: 41509001)

Features/Options:

- Metal enclosure
- Slow action \ominus , 2 NC contacts with double break
- 3 cable entries M16 x 1.5
- Actuator: Roller plunger R
- Actuating speed max. 0.5 m/s with a vertical actuating angle of 30°
- Metal roller
- Actuator can be repositioned by 4 x 90°

Notes

- When used as safety switch, secure the enclosure against slipping with appropriate means, e.g. pinning.

Dimensions

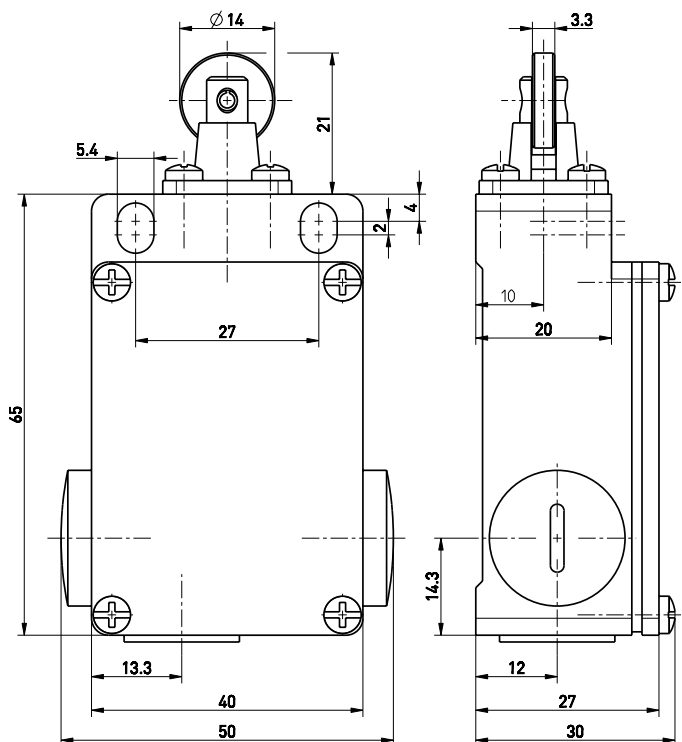

Technical data

Applied standards	EN ISO 13849-1, EN 60947-5-1, EN ISO 14119
Enclosure	aluminium die-cast, powder-coated
Switch type	type 1
Coding level	no coding
Degree of protection	IP 65 to IEC/EN 60529
B _{10d} (10 % load)	2 million
T _M	max. 20 years
Contact material	silver
Switching system	slow action, positive break NC contacts \ominus
Switching elements	2 NC contacts, type Zb
Connection	screw connection terminals
Cable cross-section	max. 2.5 mm ² (incl. conductor ferrules)
Cable entry	3 x M16 x 1.5
Rated impulse withstand voltage U _{imp}	4 kV
Rated insulation voltage U _i	400 V
Conventional thermal current I _{the}	6 A
Utilisation category	AC-15
Rated operating current/voltage I _e /U _e	6 A/400 VAC
Short-circuit protection	6 A gG/gN fuse
Mechanical life	> 1 million operations

Errors and omissions excepted.



Position switch with safety function

ES 41 R 2Ö

Material number: 1046525 (Material number old: 41509001)

Technical data

Operation cycles max. 3600/h

Ambient temperature -20 °C ... +80 °C

Repeat accuracy of switching points ± 0.1 mm

Approvals



Weight 160 g

Contact diagram

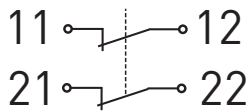

Switching diagram

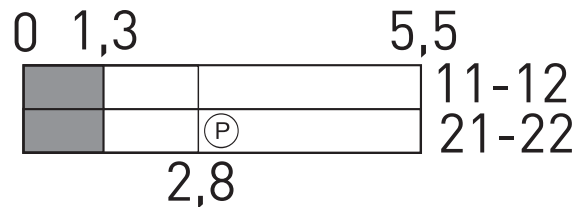

Ⓟ Positive break travel/angle