



Ex magnetic sensor Ex RC M20 1W KST - 10m -60°C Material number: 1445633

Features/Options:

- Ex zone 1 and 21
- Cold-resistant down to -60 °C
- Thermoset enclosure
- With pre-wired cable

Notes

- 2 mounting nuts are included in delivery
- The actuator is not included in the delivery of the switches

Dimensions

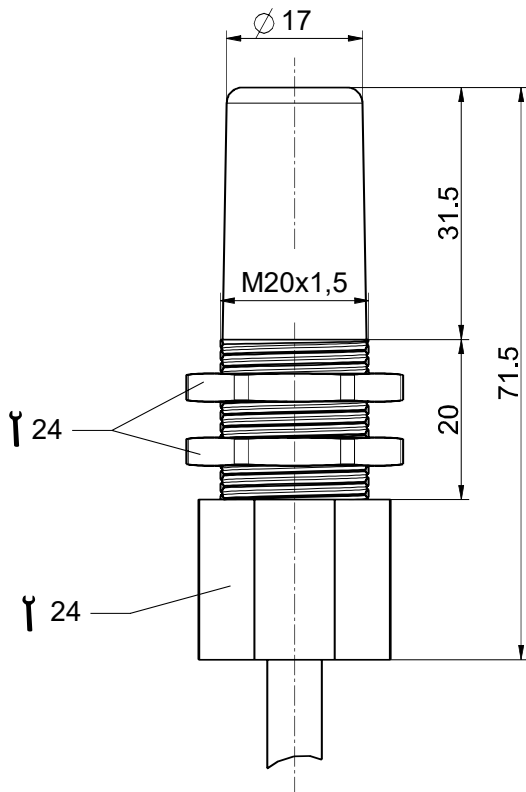

Technical data

Applied standards	EN 60947-5-2, EN 60079-0, EN 60079-18
Enclosure	thermoset, glass-fibre reinforced, impact resistant, self-extinguishing UL 94 V-0
Degree of protection	IP 67 (EN 60079-0 + IEC/EN 60529) IP 66, IP 68, IP 69 (IEC/EN 60529) IP 69K (ISO 20653)
Switching system	reed contacts
Switching elements	1 change-over contact
Connection	pre-wired cable, Silicone SIHF
Cable cross-section	3 x 0.75 mm ²
Cable length	10 m
Switching voltage	max. 250 VAC
Switching current	max. 1 A
Short-circuit current I _k	max. 2 A
Switching capacity	max. 50 W/VA
Bounce duration	max. 0.5 ms
Ambient temperature	-60 °C ... +70 °C
Mechanical life	> 1 million operations
Vibration resistance	max. 35 g
Shock resistance	max. 50 g
Impact energy	max. 7 J
Ex marking	⊕ II 2G Ex mb IIC T6 Gb, ⊕ II 2D Ex mb IIIC T80 °C Db IECEx Ex mb IIC T6 Gb Ex mb IIIC T80 °C Db

Errors and omissions excepted.



Ex magnetic sensor
Ex RC M20 1W KST - 10m -60°C
Material number: 1445633

Technical data

Approvals

DMT 01 ATEX E 058 X
IECEX BVS 07.0007 X



Weight

770 g

Contact diagram

