



Position switch with safety function

ES 14 FKU 1Ö/1S - 5m

Material number: 1189060 (Material number old: 14049003)

Features/Options:

- Thermoplastic enclosure
- Double insulated
- Mounting details to EN 50047
- With pre-wired cable
- Actuator: Ball plunger for front mounting FKU
- Actuating speed max. 0.5 m/s with a vertical actuating angle of 20°
- Vertical actuation or actuation from side possible
- Actuator with captive stainless steel ball
- Exact repeatability of switching point

Dimensions

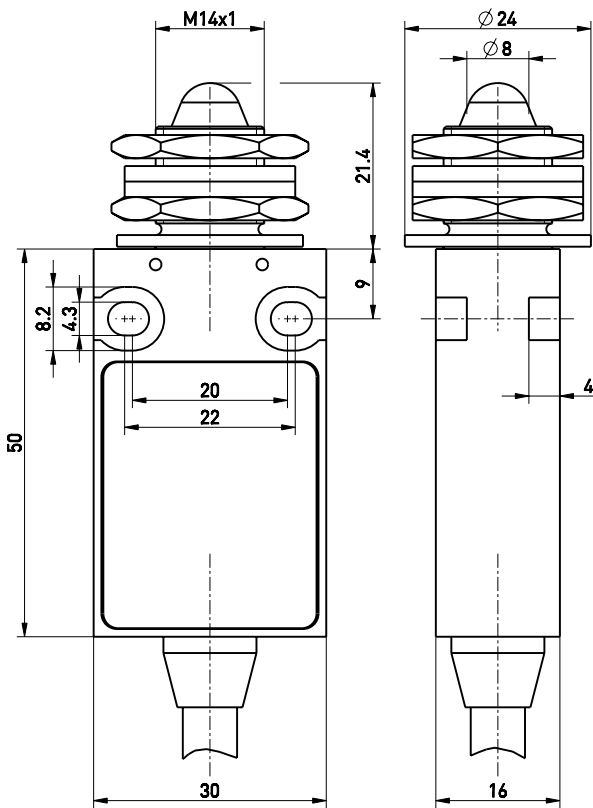

Technical data

Applied standards	EN ISO 13849-1, EN 60947-5-1, EN ISO 14119
Enclosure	thermoplastic, glass-fibre reinforced, impact resistant, self-extinguishing UL 94 V-0
Switch type	type 1
Coding level	no coding
Degree of protection	IP 67 to IEC/EN 60529
B _{10d} (10 % load)	2 million
T _M	max. 20 years
Contact material	silver
Switching system	slow action, positive break NC contacts \ominus
Switching elements	1 NC/1 NO contact, type Zb
Connection	pre-wired cable H05VV-F
Cable cross-section	4 x 0.75 mm ²
Cable length	5 m
Rated impulse withstand voltage U _{imp}	4 kV
Rated insulation voltage U _i	250 V
Conventional thermal current I _{the}	6 A
Rated operating current/voltage I _e /U _e	6 A/250 VAC; 0.25 A/230 VDC
Utilisation category	AC-15; DC-13
Short-circuit protection	6 A gG/gN fuse
Ambient temperature	-20 °C ... +75 °C
Mechanical life	> 1 million operations
Operation cycles	max. 1800/h

Errors and omissions excepted.



Position switch with safety function

ES 14 FKU 1Ö/1S - 5m

Material number: 1189060 (Material number old: 14049003)

Technical data

Repeat accuracy of switching points ± 0.1 mm

Contact opening max. 2 x 4 mm

Approvals



Weight

447 g

Contact diagram

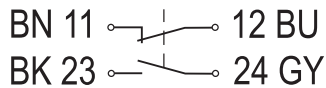

Switching diagram

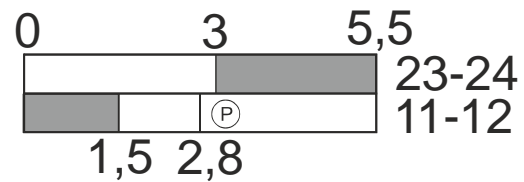

Ⓟ Positive break travel/angle