



Position switch

ES 13 WHK 1Ö/1S - 2m

Material number: 1188929 (Material number old: 13018005)

Features/Options:

- Thermoplastic enclosure
- Double insulated
- Suitable for in-line mounting
- With pre-wired cable
- Actuator: Offset roller lever with collar WHK
- Actuating speed max. 0.5 m/s with a vertical actuating angle of 40°

- Actuation only possible from right-hand side
- Free movement of actuator from left-hand side
- Metal roller
- Watertight collar for protection against penetration of dirt

Notes

- Actuator can be repositioned by 180° on request
- With plastic roller available on request

Dimensions

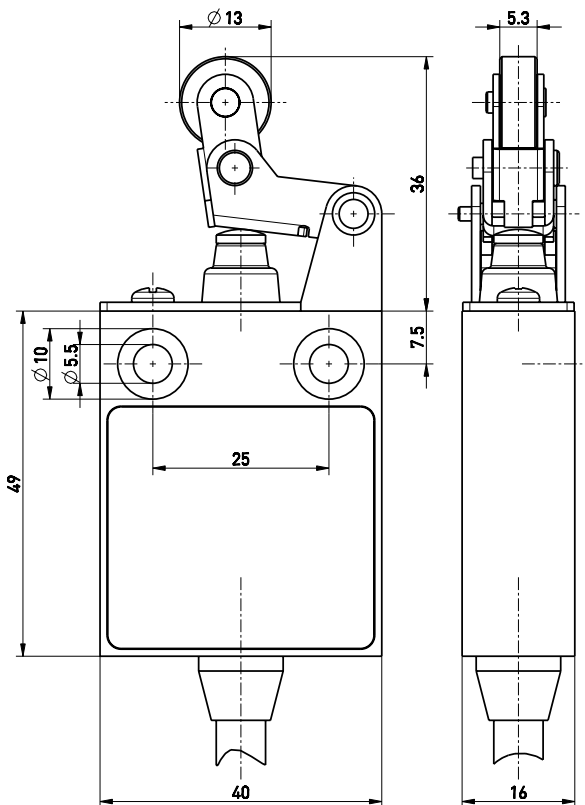

Technical data

Applied standards	EN 60947-5-1
Enclosure	thermoplastic, glass-fibre reinforced, impact resistant, self-extinguishing UL 94 V-0
Tightening torque	enclosure mounting screws: max. 5 Nm
Degree of protection	IP 67 to IEC/EN 60529
Contact material	silver
Switching system	slow action
Switching elements	1 NC/1 NO contact, type Zb
Connection	pre-wired cable H05VV-F
Cable cross-section	4 x 0.75 mm ²
Cable length	2 m
Rated impulse withstand voltage U_{imp}	4 kV
Rated insulation voltage U_i	250 V
Conventional thermal current I_{the}	6 A
Rated operating current/voltage I_e/U_e	6 A/250 VAC; 0.25 A/230 VDC; 4 A/24 VDC
Utilisation category	AC-15; DC-13
Short-circuit protection	6 A gG/gN fuse
Ambient temperature	-20 °C ... +75 °C
Mechanical life	> 1 million operations
Operation cycles	max. 1800/h

Errors and omissions excepted.



Position switch

ES 13 WHK 1Ö/1S - 2m

Material number: 1188929 (Material number old: 13018005)

Technical data

Repeat accuracy of switching ± 0.1 mm points

Contact opening max. 2 x 4.5 mm

Approvals



Weight 221 g

Contact diagram

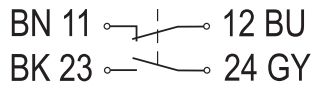

Switching diagram

