



Position switch

ES 13 TK 1Ö/1S - 2m

Material number: 1045216 (Material number old: 13036907)

Features/Options:

- Thermoplastic enclosure
- Double insulated
- Suitable for in-line mounting
- With pre-wired cable
- Actuator: Spring rod with plastic tip TK
- Wear-resistant plastic tip
- Spring rod can be actuated from any direction
- Elasticity of the spring allows for deflection above the max. switching angle of 18°

Dimensions

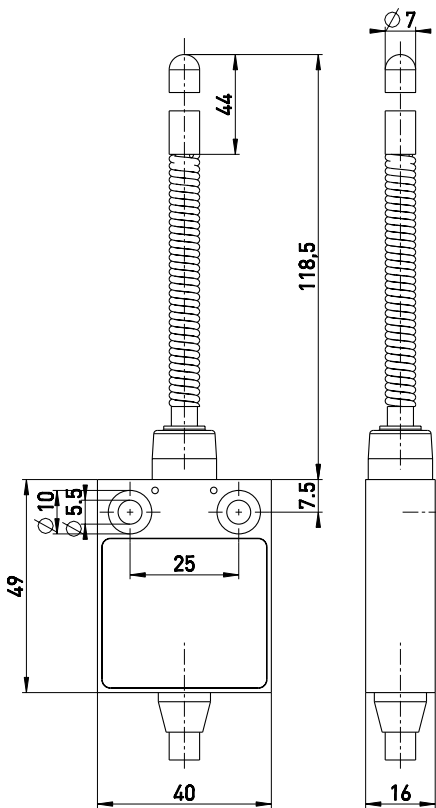

Technical data

Applied standards	EN 60947-5-1
Enclosure	thermoplastic, glass-fibre reinforced, impact resistant, self-extinguishing UL 94 V-0
Tightening torque	enclosure mounting screws: max. 5 Nm
Degree of protection	IP 67 to IEC/EN 60529
Contact material	silver
Switching system	slow action
Switching elements	1 NC/1 NO contact, type Zb
Connection	pre-wired cable H05VV-F
Cable cross-section	4 x 0.75 mm ²
Cable length	2 m
Rated impulse withstand voltage U_{imp}	4 kV
Rated insulation voltage U_i	250 V
Conventional thermal current I_{the}	6 A
Rated operating current/voltage I_e/U_e	6 A/250 VAC; 0.25 A/230 VDC; 4 A/24 VDC
Utilisation category	AC-15; DC-13
Short-circuit protection	6 A gG/gN fuse
Ambient temperature	-20 °C ... +75 °C
Mechanical life	> 1 million operations
Operation cycles	max. 1800/h
Repeat accuracy of switching points	± 0.1 mm
Contact opening	max. 2 x 4.5 mm

Errors and omissions excepted.



Position switch

ES 13 TK 1Ö/1S - 2m

Material number: 1045216 (Material number old: 13036907)

Technical data

Approvals



Weight

212 g

Contact diagram

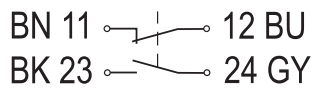

Switching diagram

