



Ex position switch

Ex 12 DS - 2m

Material number: 1189106 (Material number old: 12729311)

Features/Options:

- Ex zone 1 and 21
- Metal enclosure, hard-coated
- Snap action, change-over contact with single break
- Suitable for in-line mounting
- With pre-wired cable
- Actuator: Adjustable rocking lever DS
- Actuating speed max. 0.5 m/s with a vertical actuating angle of 45°

- Wear-resistant plastic roller
- Lever can be repositioned in 10° steps clockwise or counter-clockwise
- Attention: Please state required international approvals with your order!

Notes

- Actuator can be repositioned by 180° on request
- With metal roller available on request

Dimensions

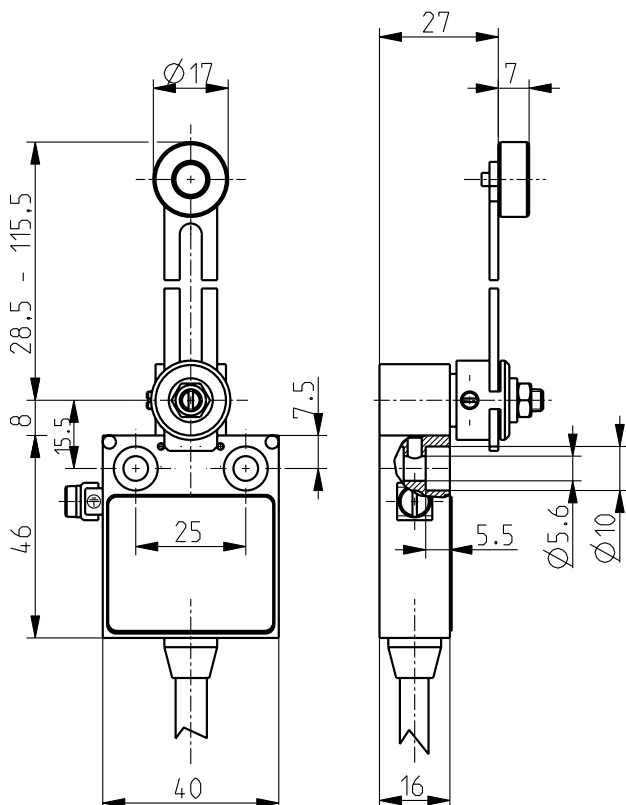

Technical data

Applied standards	EN 60079-0, EN 60079-1, EN 60079-31, EN 60947-5-1
Enclosure	aluminium die-cast, hard-coated
Degree of protection	IP 65 to IEC/EN 60529
Contact material	silver
Switching system	snap action
Switching elements	1 change-over contact with single break, type C
Connection	pre-wired cable H05VV-F
Cable cross-section	4 x 0.75 mm ² (incl. conductor ferrules)
Cable length	2 m
Rated impulse withstand voltage U _{imp}	4 kV
Rated insulation voltage U _i	250 V
Conventional thermal current I _{the}	5 A
Utilisation category	AC-15; DC-13
Rated operating current/voltage I _e /U _e	5 A/250 VAC; 0.16 A/230 VDC
Short-circuit protection	5 A gG/gN fuse
Ambient temperature	-20 °C ... +60 °C
Mechanical life	> 1 million operations
Operation cycles	max. 1800/h

Errors and omissions excepted.



Ex position switch

Ex 12 DS - 2m

Material number: 1189106 (Material number old: 12729311)

Technical data

Repeat accuracy of switching points ± 0.1 mm

Impact energy max. 7 J

Ex marking
 II 2G Ex db IIC T6 Gb
 II 2D Ex tb IIIC T80 °C Db
IECEX Ex db IIC T6 Gb
Ex tb IIIC T80 °C Db

Approvals
PTB 03 ATEX 1067 X
IECEX PTB 11.0089X



Weight 150 g

Switching diagram

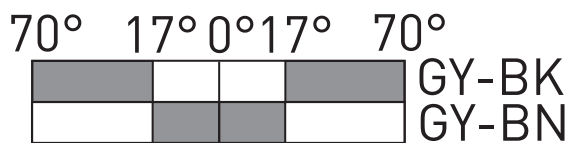

Contact diagram

