



Ex position switch

Ex 13 TK 1Ö/1S - 5m

Material number: 1045211 (Material number old: 13036902)

Features/Options:

- Ex zone 1 and 21
- Thermoplastic enclosure
- Double insulated
- Suitable for in-line mounting
- With pre-wired cable
- Actuator: Spring rod with plastic tip TK
- Wear-resistant plastic tip
- Spring rod can be actuated from any direction
- Elasticity of the spring allows for deflection above the max. switching angle of 18°
- Attention: Please state required international approvals with your order!

Dimensions

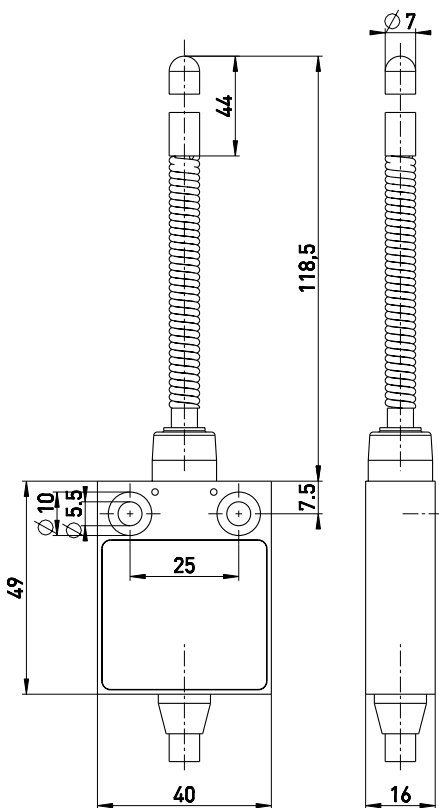

Technical data

Applied standards	EN 60947-5-1, EN 60079-0, EN 60079-1, EN 60079-31
Enclosure	thermoplastic, glass-fibre reinforced, impact resistant, self-extinguishing UL 94 V-0
Degree of protection	IP 65 (EN 60079-0 + IEC/EN 60529) IP 67 (IEC/EN 60529)
Contact material	silver
Switching system	slow action
Switching elements	1 NC/1 NO contact, type Zb
Connection	pre-wired cable H05VV-F
Cable cross-section	4 x 0.75 mm ² (incl. conductor ferrules)
Cable length	5 m
Rated impulse withstand voltage U_{imp}	4 kV
Rated insulation voltage U_i	250 V
Conventional thermal current I_{the}	T6: 6 A, T5: 3 A
Rated operating current/voltage I_e/U_e	6 A/250 VAC; 0.25 A/230 VDC
Utilisation category	AC-15; DC-13
Short-circuit protection	6 A gG/gN fuse
Ambient temperature	T6: -20 °C ... +65 °C, T5: -20 °C ... +75 °C, +90 °C with max. 3 A
Mechanical life	> 1 million operations
Operation cycles	max. 1800/h
Repeat accuracy of switching points	± 0.1 mm

Errors and omissions excepted.



Ex position switch

Ex 13 TK 1Ö/1S - 5m

Material number: 1045211 (Material number old: 13036902)

Technical data

Contact opening max. 2 x 4 mm

Impact energy max. 7 J

Ex marking
⊕ II 2G Ex db IIC T6/T5 Gb,
⊕ II 2D Ex tb IIIC
T80 °C/T95 °C Db
IECEX Ex db IIC T6/T5 Gb,
Ex tb IIIC T80 °C/T95 °C Db

Approvals
PTB 03 ATEX 1068 X
IECEX PTB 06.0053X



Weight 445 g

Switching diagram

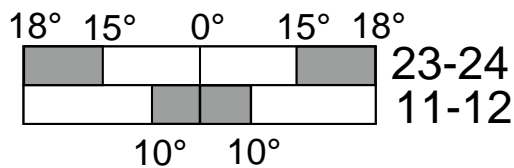

Contact diagram

