



## Emergency pull-wire switch

ZS 75 4Ö VD / 120-180 N

Material number: 1178721 (Material number old: 75941906)

### Features/Options:

- Metal enclosure
- 4 contacts
- Wire length up to 130 m

### Notes

- At 5 m distance intermediate wire supports are required. One wire thimble is provided.

### Dimensions

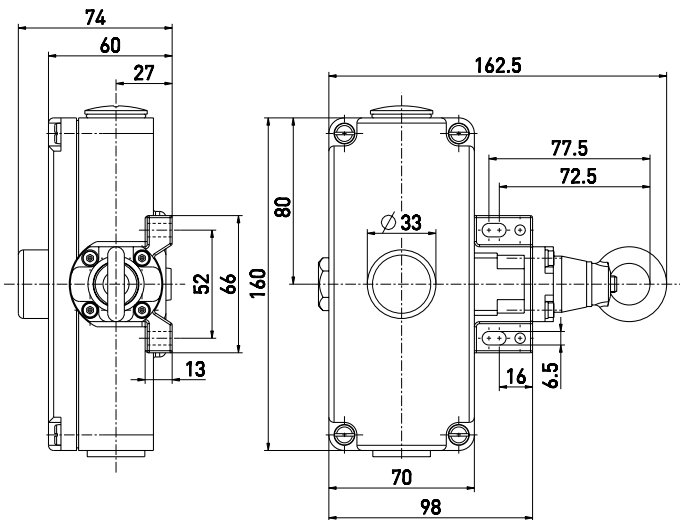

### Technical data

Applied standards	EN 60947-5-1, EN 60947-5-5, EN ISO 13850, EN ISO 13849-1
Enclosure	aluminium die-cast, powder-coated
Cover	aluminium die-cast, powder-coated
Degree of protection	IP 54 to IEC/EN 60529
$B_{10d}$ (10 % load)	100 000
$T_M$	max. 20 years
Contact material	silver
Switching elements	4 NC contacts, type Zb
Switching system	snap action, positive break NC contacts $\ominus$
Connection	screw connection terminals
Cable cross-section	min. 0.5 mm <sup>2</sup> , max. 2.5 mm <sup>2</sup> (incl. conductor ferrules)
Stripping length	6 mm
Cable entry	2 x M25 x 1.5
Rated impulse withstand voltage $U_{imp}$	6 kV
Rated insulation voltage $U_i$	400 V
Conventional thermal current $I_{the}$	6 A
Utilisation category	AC-15
Rated operating current/voltage $I_e/U_e$	6 A/400 VAC
Short-circuit protection	6 A gG/gN fuse
Ambient temperature	-25 °C ... +70 °C
Mechanical life	> 100 000 operations

Errors and omissions excepted.



## Emergency pull-wire switch

ZS 75 4Ö VD / 120-180 N

Material number: 1178721 (Material number old: 75941906)

### Technical data

Max. wire length 130 m

#### Approvals



Weight 930 g

### Switching diagram

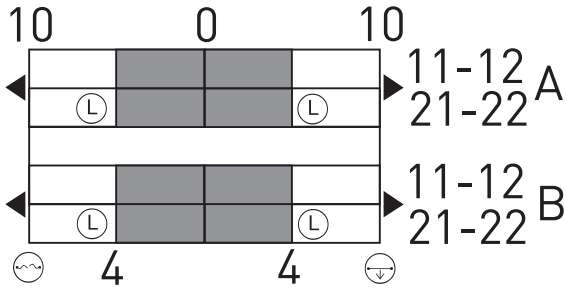

- Latching point
- Wire breakage detection
- Wire pull detection

### Contact diagram

